

UNIT I PROJECT EVALUATION AND PROJECT PLANNING

Importance of Software Project Management - Activities Methodologies - Categorization of Software Projects - Setting objectives - Management Principles - Management Control - Project portfolio Management - Cost-benefit evaluation technology - Risk evaluation - Strategic program Management - Stepwise Project Planning.

PART-A

1	<p>What is a project?</p> <p>The dictionary definitions put a clear emphasis on the project being a planned activity. The other definitions include</p> <ul style="list-style-type: none"> ✓ A Specific plan or design ✓ A planned undertaking ✓ A large undertaking
2	<p>Define software project management.(May 14)</p> <p>Software project management is the art and science of planning and leading software projects. It is a sub-discipline of project management in which software projects are planned, implemented, monitored and controlled.</p>
3	<p>What are the characteristics of a project? (Dec 12, 13)</p> <ul style="list-style-type: none"> ✓ Non-routine tasks are involved ✓ Planning is required ✓ Specific objectives are to be met ✓ The project has a predetermined time span ✓ Work is carried out for someone other than yourself ✓ Work involves several specialism ✓ People are formed into temporary work group ✓ Work is carried out in several phases ✓ Resources available are constrained ✓ The project is large and complex.
4	<p>What are the characteristics that make software projects different from other projects? (Dec 14, May 12,15)</p> <p>Invisibility - When a physical artifact is being constructed the progress being made can actually be seen. With Software, progress is not immediately visible.</p> <p>Complexity - software products contain more complexity than other engineered artifacts.</p> <p>Conformity - The 'traditional' engineer is usually working with physical. These physical systems can have some complexity, but are governed by physical laws that are consistent. Software developers have to conform to the requirements of human clients. It is not just that individual can be inconsistent.</p> <p>Flexibility - The ease with which software can be changed is usually seen as one of its strengths.</p>
5	<p>What are the three successive processes that bring a new system?(Dec 11)</p> <ul style="list-style-type: none"> ✓ The feasibility study- Evaluate the cost of the software development against the Software Engineering ✓ Planning-Outline the structure of the project ✓ Project Execution- Product Implementation activities.

6	<p>What are the phases in software development life cycle?</p> <ul style="list-style-type: none"> ✓ Requirement analysis ✓ Architecture design ✓ Detailed design ✓ Code and test ✓ Integration ✓ Qualification testing ✓ Installation ✓ Acceptance support
7	<p>List the various ways to categorize software projects.</p> <ul style="list-style-type: none"> ✓ Compulsory versus voluntary projects ✓ Information systems versus embedded systems ✓ Outsourced projects ✓ Object driven versus product driven development
8	<p>Who are project stakeholders? (May 15)</p> <p>These are people who have a stake or interest in the project. Stakeholders can be categorized as:</p> <ul style="list-style-type: none"> ✓ Internal to the project team ✓ External to the project team but within the same organization ✓ External to both the project and the organization.
9	<p>What is project steering committee? What are their roles?</p> <p>Overall authority over the project is often termed as project steering committee or project management board. The project manager runs the project on a day-to-day basis, but regularly reports to the steering committee.</p> <p>Roles:</p> <ul style="list-style-type: none"> ✓ Setting, monitoring and modifying objectives. ✓ The project manager runs the project on a day-to-day basis, but regularly reports to the steering committee.
10	<p>What are the activities of management?</p> <ul style="list-style-type: none"> ✓ Planning -deciding what is to be done. ✓ Organizing - making arrangements. ✓ Staffing-selecting the right people for the job ✓ Directing-giving instructions. ✓ Monitoring - checking on progress ✓ Controlling- taking action to remedy hold-ups ✓ Innovating-coming up with new solutions. ✓ Representing - liaising with clients, users , developers , suppliers
11	<p>Define SMART.</p> <p>S - specific, that is, concrete and well-defined</p> <p>M - measurable, that is, satisfaction of the objective can be objectively judged</p> <p>A - achievable, that is, it is within the power of the individual or group concerned to meet the target</p> <p>R - relevant, the objective must relevant to the true purpose of the project</p> <p>T - time constrained: there is defined point in time by which the objective should be achieved</p>

12	<p>What is Goals/sub-objectives?</p> <p>A goal can be allocated to an individual. Individual may have the capability of achieving goal, but not the objective on their own. A more appropriate goal or sub-objective for the software developers would be to keep development costs within a certain budget.</p> <p>e.g. Objective – user satisfaction with software product , Analyst goal – accurate requirements and Developer goal – software that is reliable</p>
13	<p>Define Management control. (Dec 18)</p> <p>Management Control System is defined a ‘set of policies and procedures designed to keep operations going according to plan.</p>
14	<p>What is project evaluation?</p> <p>Project evaluation is a step by step process of collecting, recording and organizing information about</p> <ul style="list-style-type: none"> ✓ Project results ✓ short - term outputs (immediate results of activities or project deliverables) ✓ Long - term outputs (changes in behavior, practice or policy resulting from the result.
15	<p>Why is project evaluation important?</p> <ul style="list-style-type: none"> ✓ What progress has been made? ✓ Were the desired outcomes achieved? Why? ✓ Whether the project can be refined to achieve better outcomes? ✓ Do the project results justify the project inputs?
16	<p>What is Project portfolio Management?</p> <p>Project Portfolio Management (PPM) is the centralized management of the processes, methods, and technologies used by project managers and project management offices(PMOs) to analyze and collectively manage current or proposed projects based on numerous key characteristics.</p>
17	<p>What are the key aspects of Project portfolio Management?</p> <ul style="list-style-type: none"> ✓ Portfolio definition ✓ Portfolio management ✓ Portfolio optimization
18	<p>What is objective of a project?</p> <p>Informally, the objective of a project can be defined by completing the statement: The project will be regarded as a success “if.....” Rather like post-conditions for the project, Focus on what will be put in place, rather than how activities will be carried out.</p> <p>e.g. ‘a new payroll application will be operational by 4th April’ not ‘design and code a new payroll application’</p>
19	<p>What are the steps in cost-benefit analysis?(Dec 12, 13,18)</p> <p>Cost –benefit analysis consists of two steps</p> <ul style="list-style-type: none"> ✓ Identifying and estimating all of the costs and benefits of carrying out the project and operating the delivered application. It includes development cost of system, Operating cost of system, Benefits obtained by system. ✓ Expressing these costs and benefits in common units.

20	<p>What is net profit?</p> <p>The net profit of a project is the differences between the total costs and the total income over the life of the project. Advantage is easy to calculate and disadvantages are does not show profit relative to size investment</p>
21	<p>What do you understand by payback period?(Dec 14)</p> <p>The payback period is the time taken to break even or pay back the initial investment. Normally, the project with the shortest payback period will be chosen on the basis that an organization will wish to minimize the time that a project is 'in debt'.</p> <ul style="list-style-type: none"> ✓ Advantage: Simple to calculate, not sensitive to small forecasting errors. ✓ Disadvantage: Ignores the overall profitability of the project.
22	<p>What is Return on investment?(May 12)</p> <ul style="list-style-type: none"> ✓ It provides a way of comparing the net profitability to the investment required. ✓ A performance measure used to evaluate the efficiency of an investment or to compare the efficiency of a number of different investments <p>Disadvantages</p> <ul style="list-style-type: none"> ✓ It takes no account of the timing of the cash flows. ✓ Rate of returns bears no relationship to the interest rates offered or changed by bank. ✓ $ROI = \frac{\text{average annual profit}}{\text{Total investment}} * 100$ ✓ $\text{Average annual profit} = \frac{\text{net profit}}{\text{Total no. of years}}$
23	<p>When Net present value is calculated for a project? (Dec 12)</p> <p>The calculation of net present value is a project evaluation technique that takes into account the profitability of a project and the timing of cash flows that are produced. The NPV for a project is obtained by discounting each cash flow and summing the discounted values.</p>
24	<p>What is the use of decision tree in Risk Evaluation? (May 13)</p> <p>A decision tree is a diagramming analysis technique used to help select the best course of action in situations in which future outcomes are uncertain</p>
25	<p>What is the concept of strategic programmes? (Dec 13)</p> <p>Several projects together can implement a single strategy. For example the merging of two organizations' computer systems could require several projects each dealing with particular application area. Each activity could be treated as a distinct project, but would be coordinated as a programme.</p>
26	<p>What are the steps involved in step wise planning?</p> <ul style="list-style-type: none"> ✓ Identify project scope and objectives. ✓ Identify project infrastructure. Analyze project characteristics. ✓ Identify project products and activities. ✓ Estimate effort for each activity. ✓ Identify activity risks. ✓ Allocate resources. ✓ Review / publicize plan ✓ Execute plan/ lower levels of planning.

27 Draw the diagram of overview of stepwise project planning.

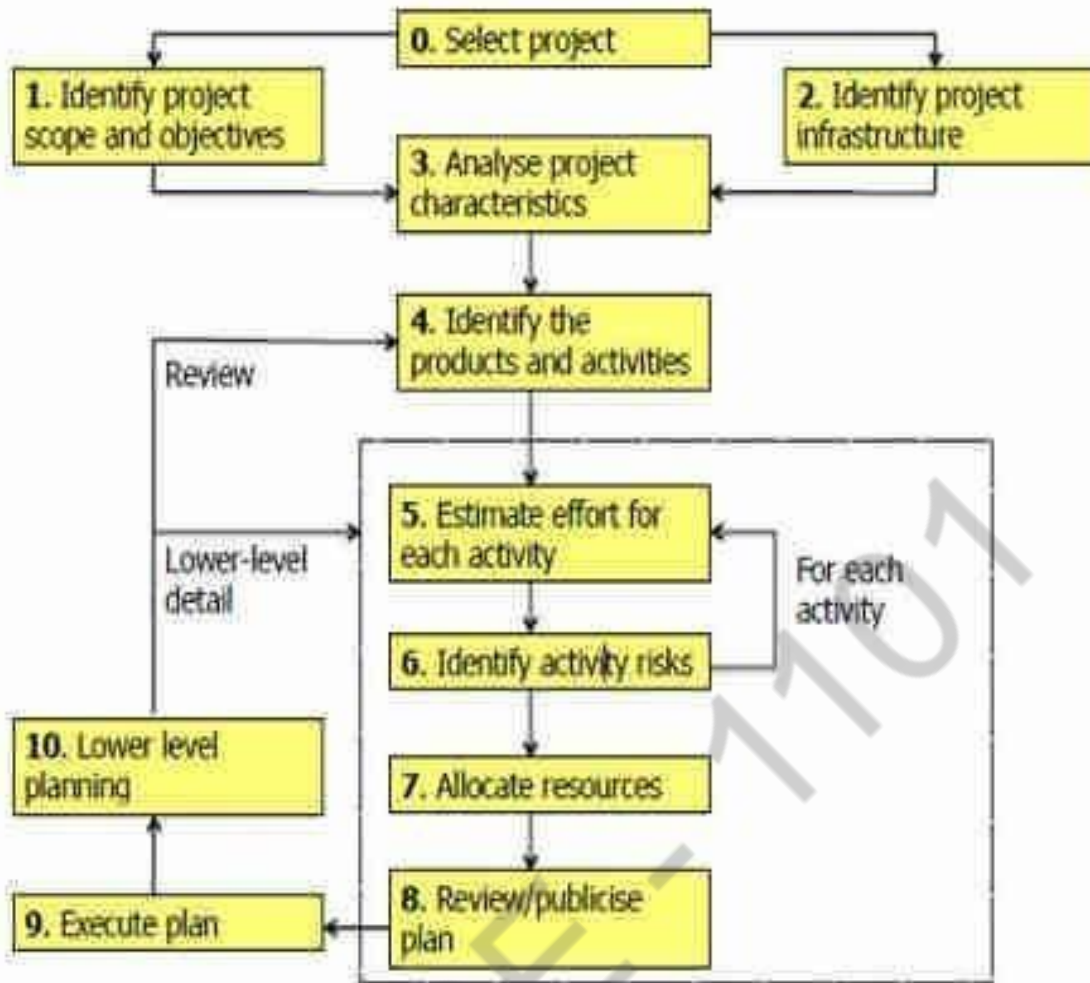

28 What is the need for software project management? (April/May 2018)

It is necessary for an organization to deliver quality product, keeping the cost within client's budget constrain and deliver the **project** as per scheduled. Hence in order, **software project management** is necessary to incorporate user requirements along with budget and time constraints.

29 Define Software Quality Metrics. (April/May 2018)

Software Quality Metrics means **measurement** of attributes, pertaining to **software quality** along with its process of development. The term "**software quality metrics**" illustrate the picture of measuring the **software** qualities by recording the number of defects or security loopholes present in the **software**.

30 Mention the need of cost benefit analysis (April/May 2019)

Cost-benefit analysis is a simple technique for comparing the business value a project will produce with the **cost** of producing it..... So project managers conduct the **cost-benefit analysis** by gathering data on the value of the **benefits** and the **cost** of the project.

31 Identify the sequence of stages involved in typical project life cycle. (April/May 2019)

A standard **project** typically has the following four major **phases**:

- Initiation
- Planning
- Implementation
- Closure.

Taken together, these **phases** represent the path a **project** takes from the beginning to its end and are generally referred to as the **project life cycle**

32 Explain two ways of setting objectives. (Apr 18)

- Answering the question 'What do we have to do to have a success?'

- Need for a project authority
 - ❖ Sets the project scope
 - ❖ Allocates/approves costs
- Could be one person - or a group
 - ❖ Project Board
 - ❖ Project Management Board
 - Steering committee

PART-B

- | | |
|---|--|
| 1 | <p>Explain the difference between software projects and other projects in detail. /How does project management methodology differ for simple projects and complex projects?(Nov/Dec 2018)</p> <ol style="list-style-type: none"> 1. Invisibility When a physical artifact such as a bridge or road is being constructed the progress being made can actually be seen. With software, progress is not immediately visible. One way of perceiving software project management is as the process of making visible that which is invisible. 2. Complexity Per dollar, pound or euro spent, software products contain more complexity than other engineered artifacts. 3. Conformity The 'traditional' engineer is usually working with physical systems and physical materials like cement and steel. These physical systems can have some complexity, but are governed by physical laws that are consistent. Software developers have to conform to the requirements of human clients. It is not just that individuals can be inconsistent. Organizations, because of lapses in collective memory, in internal communication or in effective decision making can exhibit remarkable 'organizational stupidity' that developers have to cater for. 4. Flexibility The ease with which software can be changed is usually seen as one of its strengths. However, this means that where the software system interfaces with a physical or organizational system, it is expected that, where necessary, the software will change to accommodate the other components rather than vice versa. This means the software systems are likely to be subject to a high degree of change. |
|---|--|

2 Describe about activities covered by the software project management with example.(Or) Explain the various software development life cycle activities as outlined by ISO 12207 with a neat diagram. (Dec 12,14,19 May 12, 13, 14, 15)

a. The feasibility study

This investigates whether a prospective project is worth starting – that it has a valid business case. Information is gathered about the requirements of the proposed application. Requirements elicitation can, at least initially, be complex and difficult. The client and other stakeholders may be aware of the problems they wish to overcome and the aims they wish to pursue, but not be sure about the means of achievement. The probable developmental and operational costs, along with the value of the benefits of the new system, will also have to be estimated. With a large system, the feasibility study could be treated as a project in its own right – and have its own planning sub-phase. The study could be part of a strategic planning exercise examining and prioritizing a range of potential software developments. Sometimes an organization has a policy where a group of projects is planned as a programme of development.

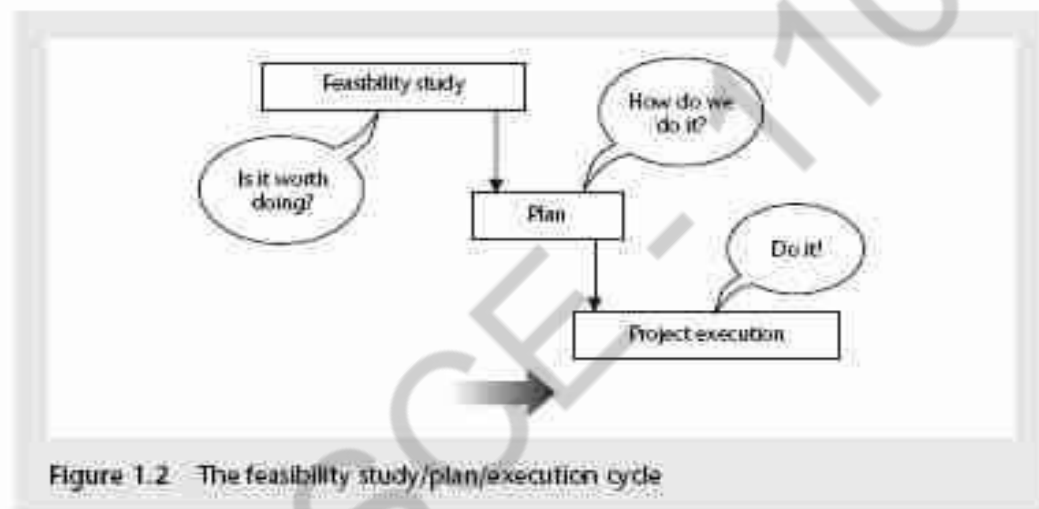

b. Planning

If the feasibility study produces results which indicate that the prospective project appears viable, then planning of the project can take place. However, for a large project, we would not do all our detailed planning right at the beginning. We would formulate an outline plan for the whole project and a detailed one for the first stage. More detailed planning of the later stages would be done as they approached. This is because we would have more detailed and accurate information upon which to base our plans nearer to the start of the later stages.

Project Planning

The biggest single problem that afflicts software developing is that of underestimating resources required for a project. Developing a realistic project plan is essential to gain an understanding of the resources required, and how these should be applied.

Types of plan:

- √ Software development plan.

The central plan, which describes how the system will be developed.

- √ Quality assurance plan.

Specifies the quality procedures & standards to be used.

√ Validation plan.

Defines how a client will validate the system that has been developed.

√ Configuration management plan.

Defines how the system will be configured and installed.

√ Maintenance plan.

Defines how the system will be maintained.

√ Staff development plan.

Describes how the skills of the participants will be developed.

c. Project execution

The project can now be executed. The execution of a project often contains design and implementation sub-phases. Students new to project planning often find it difficult to separate planning and design, and often the boundary between the two can be hazy. Essentially, design is thinking and making decisions about the precise form of the products that the project is to create. In the case of software, this could relate to the external appearance of the software, that is, the user interface, or the internal architecture. The plan lays down the activities that have to be carried out in order to create these products. Planning and design can be confused because at the most detailed level, planning decisions are influenced by design decisions. For example, if a software product is to have five major components, then it is likely that there will be five sets of activities that will create them.

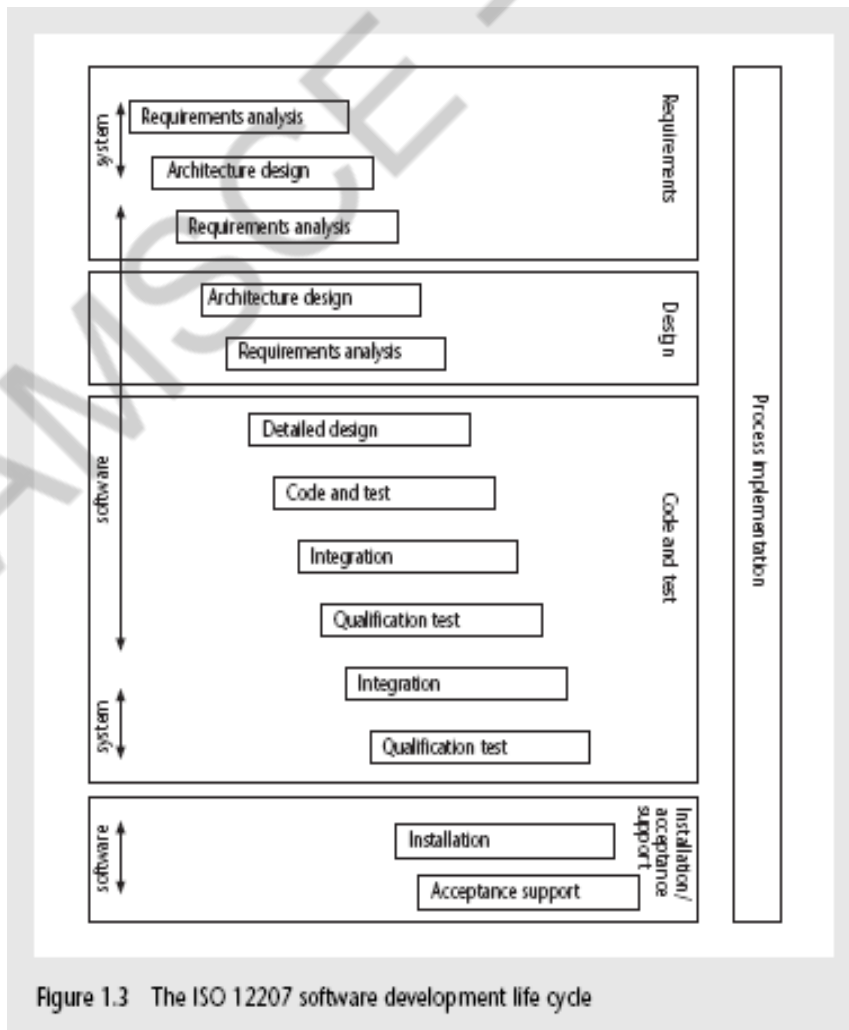

Figure 1.3 The ISO 12207 software development life cycle

Requirements analysis This starts with requirements elicitation which investigates what the potential users and their managers and employers require as features and qualities of the new system. These will relate to the system as a whole. A quality requirement might be, for instance, that the user should be able to complete a transaction within a certain time. In this case transaction time would be affected by the speed of human operation, as well as hardware and software performance. These are 'customer-facing' requirements.

- **Architecture design** This maps the requirements to the components of the system that is to be built. At the system level, decisions will need to be made about which processes in the new system will be carried out by the user and which can be computerized. This design of the system architecture thus forms an input to the development of the software requirements. A second architecture design process then takes place which maps the software requirements to software components.

- **Code and test** This could refer to writing code in a procedural language such as C# or Java, or could refer to the use of an application-builder such as Microsoft Access. Initial testing to debug individual software components would be carried out at this stage.

- **Integration** The individual components are collected together and tested to see if they meet the overall requirements. Integration could be at the level of software where different software components are combined, or at the level of the system as a whole where the software and other components of the system such as the hardware platforms and networks and the user procedures are brought together.

- **Qualification testing** The system, including the software components, has to be tested carefully to ensure that all the requirements have been fulfilled.

- **Installation** This is the process of making the new system operational. It would include activities like setting up standing data (such as payroll details for employees if this were a payroll system). It would also include setting system parameters, installing the software onto the hardware platforms and user training.

- **Acceptance support** This is the resolving of problems with the newly installed system, including the correction of any errors that might have crept into the system and any extensions and improvements that are required. It is possible to see software maintenance as a series of minor software projects. In many environments, most software development is in fact maintenance.

3 **What are the activities involved by management? List the problems with software projects./List out the critical risk in project planning(Dec 12,18)**

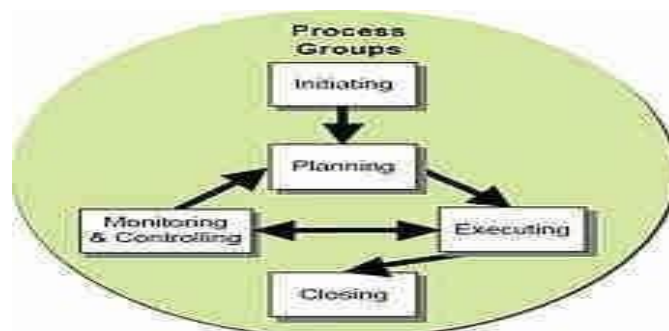

It has been suggested that management involves the following activities:

- Planning – deciding what is to be done;
- Organizing – making arrangements;
- Staffing – selecting the right people for the job etc;
- Directing – giving instructions;
- Monitoring – checking on progress;
- Controlling – taking action to remedy hold-ups;
- Innovating – coming up with new solutions
- Representing – liaising with clients, users, developer, suppliers and other Stakeholders

1. Planning:

Planning refers to determination of future course of action to achieve desired goals. It means deciding in advance what to do, how to do it, when to do it and who is to do it. It is an “executive action that embodies the skills of anticipating, influencing and controlling the nature and direction of change”. Planning precedes all other functions of a manager.

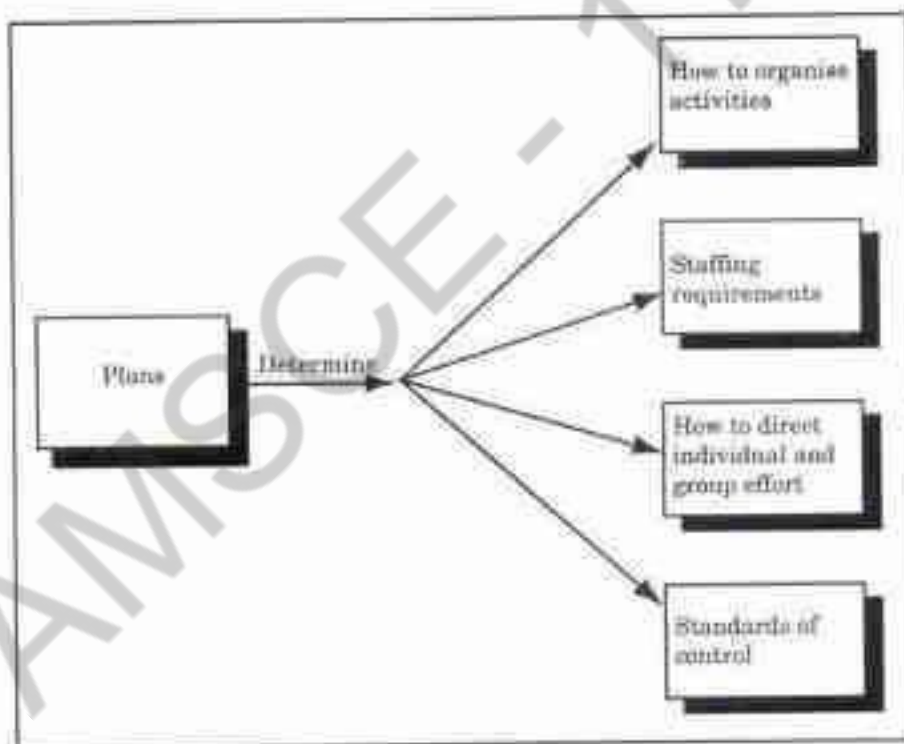

The primacy of planning in management

A planning process involves the following steps:

- (1) Being aware of opportunities or developments marks the beginning of planning process. This involves assessment of strengths and weaknesses of the environment in and outside the business organization.
- (2) Determination of goals for the organization and the individual organizational units in the light of new opportunities developments.
- (3) Establishment of critical planning premises regarding the internal and external

environments in which the plans will operate. This involves identification of strengths and weaknesses of the business enterprise in terms of products, markets, processes, technologies, personnel, etc.

(4) Identification of the alternative courses of action to achieve the objectives.

(5) Evaluation of the alternative courses of action in the light of their impact on achievement of the objectives.

(6) Selection of the best alternative course of action.

(7) Formulation of the derivative plans for supporting the plan.

It may be noted that each of the above steps in the planning process requires a lot of information regarding the internal and external environment in which the plans have to operate. The information regarding the external environment includes economic trends, technological changes, availability and cost of various resources, etc.

The information regarding the internal environment includes sales forecasts, financial resources and plans, state of availability of resources in the company, etc. A manager also needs various tools for analysis of the information regarding the environment.

2. Organizing:

Organizing involves analysis of activities to be performed to meet the requirements of plan, grouping them so that they could be assigned to people or groups of people in organizational units and delegation of authority to use organization's resources to perform the responsibilities so assigned. Organizing relates to the people, tasks and technology. Since these factors differ from organization to organization, there is no typical organizational design that would be suitable for all organizations. The organization structure has to be designed according to the specific requirements and conditions of the organization. As the people, tasks and technology are subject to dynamics of environment, the organizations are restructured in the light of changing business environment. Organization structures and information systems are closely related to each other. If the organization structure is the body of the business enterprise, information system is its nervous system.

The organization structure should be designed keeping in view the natural flow of information in the business enterprise. The performance measurement schemes must match the flow of information and the organization structure.

Ideally, any change in information systems should cause corresponding change in the organization structure; otherwise the information systems would not be able to reflect the plans of the business. For example, the advancements in data base technologies and use of distributed information systems are having their own impact on the way organization structures are designed today.

3. Staffing:

Staffing is the process of manning the organization structure. A manager should ensure that the right type of people fill up the positions in the organization structure. Staffing involves selection, appraisal and development of personnel in the organization. The common mistake that a manager commits is to ignore the staffing activity, leaving it to personnel department. The staffing activity is too important to be routines in the personnel department. As the manager's performance depends, to a great extent, on

the performance of his sub-ordinates, any neglect of staffing function could adversely

AMSCCE - 1101

affect the managerial effectiveness. With the increasing interdependence of various functions, appraisal of staff is becoming more complex. There is a need to use more advanced techniques of performance appraisal. These techniques can be applied with the help of IT infrastructure.

4. Directing:

Directing involves instructing, guiding and inspiring people in the organization to put in their best to achieve the common goals of the organization. Thus, directing relates to the process of motivating, leading and communicating with the people in the organization in order to achieve the objectives of the company.

Dissemination of information plays a crucial role in directing the efforts of people in the enterprise. In a business enterprise with operations spread over a wide geographical area, the personnel have to be mobile and are likely to be located far away from other members of the team and the immediate superior in the managerial hierarchy. Directing the subordinates, thus, becomes difficult because the communication may be quite expensive and may not reach the destination in time. Today, the information systems are the vehicles of formal communication.

The facility of e-mail and use of the Intranet has transformed the way formal communication takes place in business enterprises. Seamless flow of information across various departments with the help of information systems can also help in reducing the communication gaps that are many-a-time the main cause of employee dissatisfaction.

5. Controlling:

Controlling is a process that analyses whether the actions are being taken as per plans and takes corrective action to make them to conform to plans. Thus, planning is the basis of controlling. It focuses on activities that are being performed and the outcomes of these activities in terms of their impact on the achievement of plan objectives. Increasing size of the business enterprises has made all the more a difficult activity. Increased competition in the market requires greater delegation of work and decentralization of decision making in order to ensure quicker response in the operations of the business enterprise. Thus, controlling plays an important role in ensuring efficiency and effectiveness of the enterprise. The information systems play an important role in the control process. These systems not only help in measuring the performance of operations but also help in identifying deviations of performance from plans.

The comparison between planned and actual performance is then analysed with the help of information systems to identify reasons for deviations. The environmental information is used to identify such reasons. Information regarding what actions are being taken or what is happening in the internal and external environments of business is essential for exercising control. Earlier, most of such information used to come by way of personal observation by the manager. Increasing size of the business enterprise has made personal observation a very difficult form of control. There is greater reliance on written reports. With the business becoming more knowledge intensive activity and composition of personnel of the enterprise getting dominated by knowledge workers, the measurement of performance is becoming more complex. Simple tabular reports

with regard to achievement of quantified goals are not adequate for controlling.

AMSCCE - 1101

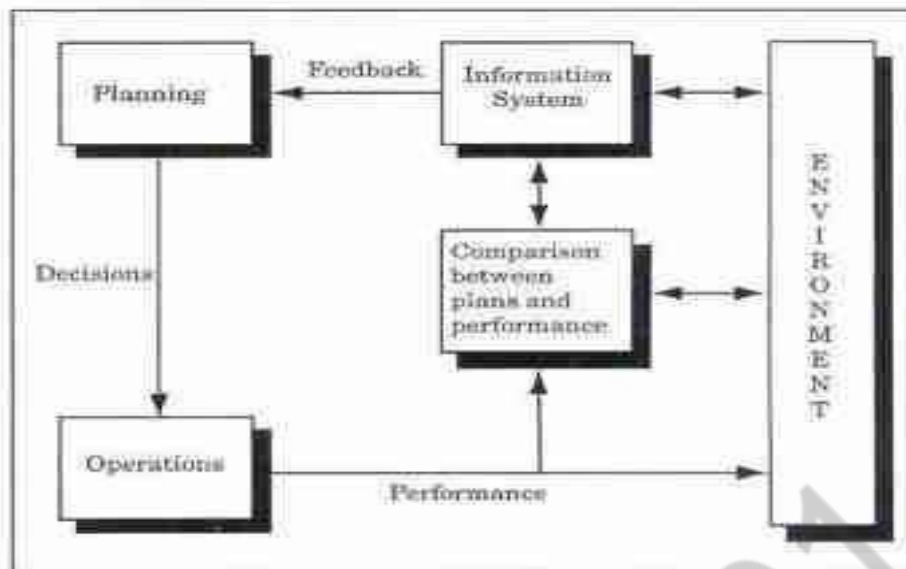

Elements of the control process

Controlling function uses information regarding the planned performance and actual performance to arrive at deviations. Efficient information systems not only identify these deviations but also help in analyzing the deviations to pinpoint reasons for deviation. They also help in modifying the plans quickly in the light of the feedback. The concept of flexible budgeting has become popular due to availability of better information processing facilities. With the availability of real time information systems, the information regarding performance flows quickly. This helps in exercising control quickly, resulting in lower cost of planning mistakes.

Problem with software projects are:

- Poor estimates and plans.
- Lack of quality standards and measures.
- Lack of guidance about making organizational decisions.
- Lack of techniques to make progress visible.
- Incorrect success criteria.

Problems occur from time to time and fixing them in a timely fashion is essential to achieve correctness of a system and avoid delayed deliveries of products. The above list looks at the project from the manager's point of view. What about the staff who make up the members of the project team? Below is a list of the problems identified by a number of Computing and Information Systems degree students who had just Completed a year's industrial placement.

4	<p>Discuss about management control in detail.(or) Draw the project control life cycle. (Apr 19)</p> <p>Management, in general, can be seen as the process of setting objectives for a system and then monitoring the system to see what its true performance is. In the 'real world' is shown as being rather formless. Especially in the case of large undertakings, there will be a lot going on about which management should be aware. This will involve the local managers in data <i>collection</i>. Bare details, such as 'location X has processed 2000 documents', will not be very useful to higher management: <i>data processing</i> will be</p>
---	--

AMSCCE - 1101

needed to transform this raw *data* into useful *information*. This might be in such forms as 'percentage of records processed', 'average documents processed per day per person' and 'estimated completion date'. In our example, the project management might examine the 'estimated completion date' for completing data transfer for each branch. These can be checked against the overall target date for completion of this phase of the project.

In effect they are comparing actual performance with one aspect of the overall project objectives. They might find that one or two branches will fail to complete the transfer of details in time. They would then need to consider what to do. The project manager would need to calculate carefully what the impact would be in moving staff from particular branches. This is modeling the consequences of a potential solution. Several different proposals could be modeled in this way before one was chosen for implementation.

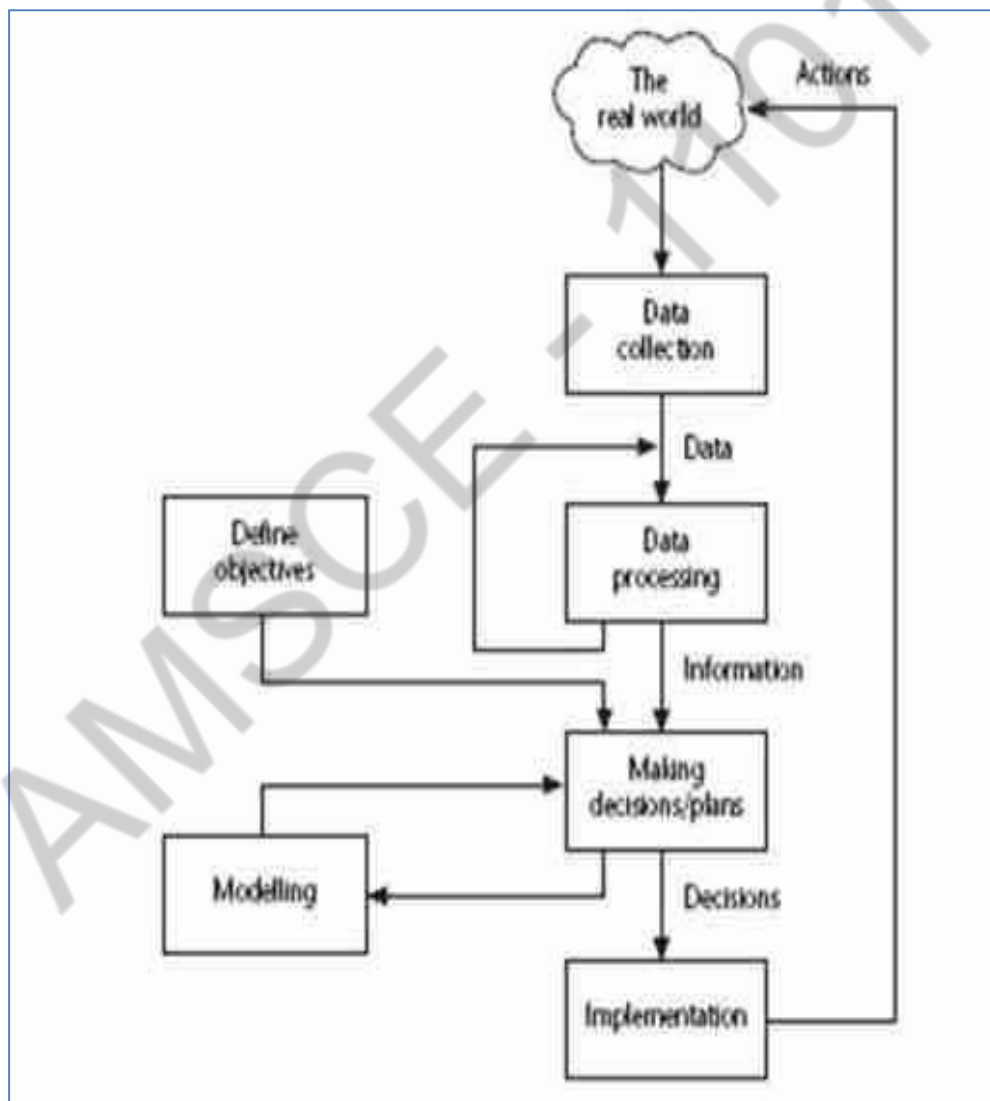

Fig 1.2 : Project Control Cycle

The Project Control Cycle

Management, in general, can be seen as the process of setting objectives for a system and then monitoring the system to see what its true performance is. In Figure The 'real world' is shown as being rather formless. Especially in the case of large undertakings, there will be a lot going on about which management should be

AMSCCE - 1101

As an example, take an IT project that is to replace locally held paper-based records with a centrally-organized database. It might be that staff in a large number of offices that are geographically dispersed need training and then need to use the new IT system to set up the back-log of manual records on the new database. It might be that the system cannot be properly operational until the last record has been transferred. It might also be the case that the new system will be successful only if new transactions can be processed within certain time cycles. The managers of the project ought to be asking questions about such things as how effective training has been, how many records have still to be transferred to the new database and transfer rates. This will involve the local managers in data collection. Bare details, such as 'location X has processed 2000 documents' will not be very useful to higher management: data processing will be needed to transform this raw data into useful information. This might be in such forms as 'percentage of records processed', 'average documents processed per day per person' and 'estimated completion date'.

In the example above, the project leader might examine the 'estimated completion date' for completing data transfer for each branch and compare this with the overall target date for completion of this phase of the project. In effect they are comparing actual performance with one aspect of the overall project objectives. They might find that one or two branches are not going to complete the transfer of details in time, and would then need to consider what to do (this is represented in Figure 1.2 by the box making decisions/plans). One possibility would be to move staff temporarily from one branch to another. If this is done, there is always the danger that while the completion date for the one branch is pulled back to before the overall target date, the date for the branch from which staffs are being moved is pushed forward beyond that date. The project manager would need to calculate carefully what the impact would be in moving staff from particular branches. This is modeling the consequences of a potential solution.

Several different proposals could be modeled in this way before one was chosen for implementation. Having implemented the decision, the situation needs to be kept under review by collecting and processing further progress details. For instance, the next time that progress is reported, a branch to which staff has been transferred might still be behind in transferring details. This might be because the reason why the branch has got behind in transferring details is because the manual records are incomplete and another department, for whom the project has a low priority, has to be involved in providing the missing information. In this case, transferring extra staff to do data input will not have accelerated data transfer.

5	<p>Explain in detail about setting objectives. (Apr 18)</p> <ul style="list-style-type: none">• Answering the question 'What do we have to do to have a success?'• Need for a project authority<ul style="list-style-type: none">❖ Sets the project scope❖ Allocates/approves costs• Could be one person - or a group<ul style="list-style-type: none">❖ Project Board❖ Project Management Board❖ Steering committee
---	---

AMSCCE - 1101

Objectives

Informally, the objective of a project can be defined by completing the statement:

The project will be regarded as a success "if....."

Rather like post-conditions for the project

Focus on what will be put in place, rather than how activities will be carried out

Objectives should be SMART

An objective is a statement which describes what an individual, team or organisation is hoping to achieve. Objectives are 'SMART' if they are specific, measurable, achievable, realistic and, timely (or time-bound).

S - specific, that is, concrete and well-defined

M - measurable, that is, satisfaction of the objective can be objectively judged

A - achievable, that is, it is within the power of the individual or group concerned to meet the target

R - relevant, the objective must be relevant to the true purpose of the project

T - time constrained, there is a defined point in time by which the objective should be achieved

1. Specific

There are a number of different ways in which SMART objectives can be set, one method is to start by identifying what you want the individual to do or achieve that reflects both the departmental or team objectives.

For example: You may be a Senior Lecturer and your department is looking at ways to improve the student experience as one of its objectives or priorities (this may be linked to results from the student satisfaction survey or feedback from other sources). You are responsible for reviewing two lecturers and it would therefore be appropriate to look at their role in this departmental priority. What does the Department need them to achieve? Is it an increase in student satisfaction in a certain area (e.g. learning resources)? Is it reducing the number of students who don't progress on to the second year of studies? Etc.

You may be a manager in a Professional Services department and your department is also looking at ways to improve the student experience as one of its objectives or priorities. What does the department need the staff you manage to achieve? Is it the introduction of new processes/procedures in order to improve the service given to either students directly or academic departments? Is it maintaining a certain (high) level of service to students/staff over a period of time?

When setting SMART objectives wherever you are within the organization and whatever your role, as a reviewer you will need to have as much clarity as possible about what you want or need your reviewer to achieve.

2. Measurable

Having identified what needs to be achieved and having written this as a statement (in the box above) you then apply the SMART criteria to it.

For example: Specific: For the lecturer: Increase student satisfaction levels in the learning resources provided by the department. What kind of increase are you looking for - a small % increase or a large one? What learning resources are you referring to?

For the administrator: Reduce the amount of time it takes to respond to academic

AMSCCE - 1101

departmental requests for information. What reduction are you aiming for? What do you mean by respond to? Do you really mean all academic departmental requests for information or a particular area? Measurable

For both examples – what measures are you going to use? Clarification is needed for both. How will you know when the objective has been achieved? So for the lecturer the objective may now look something like the example below: Increase student satisfaction levels in the 201X student satisfaction survey by 25% in the learning resources provided for x course. For the administrator the objective may have changed slightly to look as follows: Ensure all academic departmental requests for information on x are dealt with within 3 working days by October 201X.

3. Achievable

This is where you need to consider the context, abilities etc of the individual that you are expecting to do this work. Is it something that they would be able to do? It may be that the individual would need support in the form of resources, training/development etc in order to achieve the objective set (you would note these down in sections C & D of the SRDS form). It might be that the time frame that you place on the objective (which is currently missing from one of the examples) makes it less achievable so check this as well.

4. Relevant

Double check that the statement you are now crafting reflects both what is needed by the department and fits in with the expectations of the individual as described in their job summary/ job description.

5. Time Constrained

A deadline, date or time when the objective will be accomplished or completed is necessary and must be included so as to make the objective measurable. A deadline helps to create the necessary urgency, prompts action and focuses the minds of those who are accountable for the commitments that they have made through the objectives. Not setting a deadline reduces the motivation and the urgency of those required to perform the tasks. Ask yourself if the objective can be accomplished within the deadlines which have been established, bearing in mind other possible competing demands which may cause delay.

Goals/sub-objectives

These are steps along the way to achieving the objective. Informally, these can be defined by completing the sentence...

Objective X will be achieved

IF the following goals are all achieved

A.....

B.....

C... etc

Often a goal can be allocated to an individual. Individual may have the capability of achieving goal, but not the objective on their own e.g.

- ❖ Objective – user satisfaction with software product
- ❖ Analyst goal – accurate requirements

- ❖ Developer goal - software that is reliable

AMSCE - 1101

Measures of effectiveness

How do we know that the goal or objective has been achieved?

By a practical test, that can be objectively assessed.

e.g. for user satisfaction with software product:

- ❖ Repeat business – they buy further products from us
- ❖ Number of complaints – if low etc

AMSCCE - 1101

6	<p>Explain in detail about Project Portfolio Management.</p> <ul style="list-style-type: none">❖ Strategic and operational assessment carried by an organization on behalf of customer is called portfolio management [third party developers]❖ They make use of assessment of any proposed project themselves.❖ They ensure for consistency with the proposed strategic plan.❖ They proposed project will form part of a portfolio of ongoing and planned projects❖ Selection of projects must take account of possible effects on other projects in the portfolio (example: competition of resource) and the overall portfolio profile (example: specialization versus diversification). <p>When there are many projects run by an organization, it is vital for the organization to manage their project portfolio. This helps the organization to categorize the projects and align the projects with their organizational goals.</p> <p>Project Portfolio Management (PPM) is a management process with the help of methods aimed at helping the organization to acquire information and sort out projects according to a set of criteria.</p> <p>Objectives of Project Portfolio Management</p> <p>Same as with financial portfolio management, the project portfolio management also has its own set of objectives. These objectives are designed to bring about expected results through coherent team players.</p> <p>When it comes to the objectives, the following factors need to be outlined.</p> <ul style="list-style-type: none">❖ The need to create a descriptive document, which contains vital information such as name of project, estimated timeframe, cost and business objectives.❖ The project needs to be evaluated on a regular basis to ensure that the project is meeting its target and stays in its course.❖ Selection of the team players, who will work towards achieving the project's objectives. <p>Benefits of Project Portfolio Management</p> <p>Project portfolio management ensures that projects have a set of objectives, which when followed brings about the expected results. Furthermore, PPM can be used to bring out changes to the organization which will create a flexible structure within the organization in terms of project execution. In this manner, the change will not be a threat for the organization.</p> <p>The following benefits can be gained through efficient project portfolio management:</p> <ul style="list-style-type: none">❖ Greater adaptability towards change.❖ Constant review and close monitoring brings about a higher return.❖ Management's perspectives with regards to project portfolio management are seen as an 'initiative towards higher return'. Therefore, this will not be considered to be a detrimental factor to work.
---	--

- ❖ Identification of dependencies is easier to identify. This will eliminate some inefficiency from occurring.
- ❖ Advantage over other competitors (competitive advantage).
- ❖ Helps to concentrate on the strategies, which will help to achieve the targets rather than focusing on the project itself.
- ❖ The responsibilities of IT are focused on part of the business rather than scattering across several.
- ❖ The mix of both IT and business projects are seen as contributors to achieving the organizational objectives.

Project Portfolio Management Tools

There are many tools that can be used for project portfolio management. Following are the essential features of those tools:

- ❖ A systematic method of evaluation of projects.
- ❖ Resources need to be planned.
- ❖ Costs and the benefits need to be kept on track.
- ❖ Undertaking cost benefit analysis.
- ❖ Progress reports from time to time.
- ❖ Access to information as and when its required.
- ❖ Communication mechanism, which will take through the information necessary.

Techniques Used to Measure PPM

There are various techniques, which are used to measure or support PPM process from time to time. However, there are three types of techniques, which are widely used

- ❖ Heuristic model.
- ❖ Scoring technique.
- ❖ Visual or Mapping techniques.

The use of such techniques should be done in consideration of the project and organizational objectives, resource skills and the infrastructure for project management.

Why Project Managers to Focus on PPM?

PPM is crucial for a project to be successful as well as to identify any back lags if it were to occur. Project Managers often face a difficult situation arising from lack of planning and sometimes this may lead to a project withdrawal. It's the primary responsibility of project managers to ensure that there are enough available resources for the projects that an organization undertakes. Proper resources will ensure that the project is completed within the set timeline and delivered without a compromise on quality.

Project managers also may wish to work on projects, which are given its utmost priority and value to an organization. This will enable project managers to deliver and receive support for quality projects that they have undertaken. PPM ensures that these objectives of the project management will be met.

The Five Question Model

The five question model of project portfolio management illustrates that the project

manager is required to answer five essential questions before the inception as well as

AMSCCE - 1101

during the project execution. The answers to these questions will determine the success of the implementation of the project. Therefore, all the project managers of the organization need to have an awareness of the organizational project portfolio management in order to contribute to the organizational goals when executing respective projects.



AMSCCE-1101

7 Explain in detail about cost-benefit evaluation techniques and its methods with examples. (May 12, 13,14,15,19,Dec 14)

Various cost-benefits Evaluation Techniques are

- √ Net profit
- √ Payback period
- √ Return on investment
- √ Net present value
- √ Internal rate of return

1. Net profit

- ❖ Difference between total cost and total income
- ❖ Pros: Easy to calculate
- Cons
- ❖ Does not show profit relative to size investment (e.g., consider Project 2)
- ❖ Does not consider timing of payments (e.g., Projects 1 and 3)
- ❖ Not very useful other than for "back of envelope" evaluations

2. Payback period

- ❖ The payback period is the time taken to recover the initial investment or is the length of time required for cumulative incoming returns to equal the cumulative costs of an investment

Advantages

- ❖ Simple and easy to calculate.
- ❖ It is also a series of method of evaluating investments

Disadvantages

- ❖ It attaches no value to cash flows after the end of payback period
- ❖ It makes no adjustments for risk

Four project cash flow projections				
Year	Project1	Project2	Project3	Project4
0	-100,000	-100,000	-100,000	-120,000
1	10,000	200,000	30,000	30,000
2	20,000	200,000	30,000	30,000
3	10,000	200,000	30,000	30,000
4	20,000	200,000	30,000	30,000
5	100,000	300,000	50,000	75,000
Net profit	50,000	100,000	50,000	75,000

- ❖ It is not directly related to wealth maximization as NPV is.
- ❖ It ignores the time value of money.
- ❖ The "cut off" period is arbitrary.

Project 1 = 10,000+10,000+10,000+20,000+1,00,000=1,50,000

Project 2 = 2,00,000+2,00,000+2,00,000+2,00,000+3,00,000=11,00,000

Project 3 = 30,000+30,000+30,000+30,000 + 75,000 =1,95,000

3. Return on investment

- ❖ It provides a way of comparing the net profitability to the investment required
- ❖ A performance measure used to evaluate the efficiency of an investment or to compare the efficiency of a number of different investments

Disadvantages

- ❖ It takes no account of the timing of the cash flows.
- ❖ Rate of returns bears no relationship to the interest rates offered or changed by bank.

$$\text{ROI} = \frac{\text{average annual profit}}{\text{total investment}} * 100$$

$$\text{average annual profit} = \frac{\text{net profit}}{\text{total no. of years}}$$

Calculate ROI for project 1.

Ans: Total investment =1,00,000

Net profit = 50,000

Total no. of year = 5

Average annual profit=50,000/5=10,000rs

ROI= (10,000/1,00,000) *100 = 10%

4. Net present value

- ❖ A project evaluation technique that takes into account the profitability of a project and the timing of the cash flows that are produced.
- ❖ Sum of all incoming and outgoing payments, discounted using an interest rate, to a fixed point in time (the present)
- ❖ Present value = (value in year t)/(1+r)^t

Pros:

- ❖ Takes into account profitability
- ❖ Considers timing of payments Considers economic situation through discount rate

Cons: Discount rate can be difficult choose

5. Internal rate of return (IRR)

- ❖ Internal rate of return (IRR) is the discount rate that would produce an NPV of 0 for the project. It can be used to compare different investment opportunities
- ❖ Pros: Calculates figure which is easily to interest rates

Cons: Difficult to calculate (iterative)

8	<p>Explain risk evaluation.(Dec 11,12,14, May 12,14,15,18)</p> <p>Risk evaluation is meant to decide whether to proceed with the project or not, and whether the project is meeting its objectives.</p> <p>Risk Occurs:</p> <ul style="list-style-type: none">❖ When the project exceed its original specification❖ Deviations from achieving it objectives and so on. <p>Every project involves risk. The project risks which prevent the project being completed successfully and the business risk that the delivered products are nor profitable.</p>
---	---

AMSCCE - 1101

Risk evaluation consists of

- ❖ Risk identification and ranking
- ❖ Risk and NPV
- ❖ Cost benefit analysis
- ❖ Risk profile analysis

Risk identification and ranking

- ❖ Identify the risk and give priority.
- ❖ Could draw up draw a project risk matrix for each project to assess risks
- ❖ Project risk matrix used to identify and rank the risk of the project

Example of a project risk matrix

<i>Risk</i>	<i>Importance</i>	<i>Likelihood</i>
Software never completed or delivered	H	—
Project cancelled after design stage	H	—
Software delivered late	M	M
Development budget exceeded $\leq 20\%$	L	M
Development budget exceeded $> 20\%$	M	L
Maintenance costs higher than estimated	L	L
Response time targets not met	L	H

Risk and net present value

- ❖ Where a project is relatively risky it is common practice to use a higher discount rate to calculate the NPV. The risk premium be an additional 2 % for an safe project or 5 % for a fairly risky project
- ❖ Projects may be categorized as high, medium or low risk using a scoring method and risk premiums designated for each category.

Cost-benefit analysis

- ❖ A rather more sophisticated approach to the evaluation of risk is to consider each possible outcome, probability of its occurring and the corresponding value of the outcome.
- ❖ Rather than a single cash flow forecast for a project, we will then have a set of cash flow forecasts, each with an associated probability of occurring.
- ❖ The value of the project is then obtained by summing of the cost or benefit for each possible outcome weighted by its corresponding probability.
- ❖ Drawback: Does not take full account of worst-case scenarios.(averaging out the negative and positive outcomes of the scenarios)

Risk profile analysis

- ❖ An approach which attempts to overcome some of the objections to cost benefit averaging is the construction of risk profiles using sensitivity analysis.
- ❖ This makes use of “risk profiles” using sensitivity analysis.

- ❖ It compares the sensitivity of each factor of project profiles by varying

AMSCE - 1101

Parameters which affect the project cost benefits.

- ❖ Eg: Vary the original estimates of risk plus or minus 5% and re-calculate the expected cost benefits.
- ❖ P1 depart far from p2, have large variation
- ❖ P3 have much profitable than expected
- ❖ All three projects have the same expected profit
- ❖ Compare to p2, p1 is less risky.

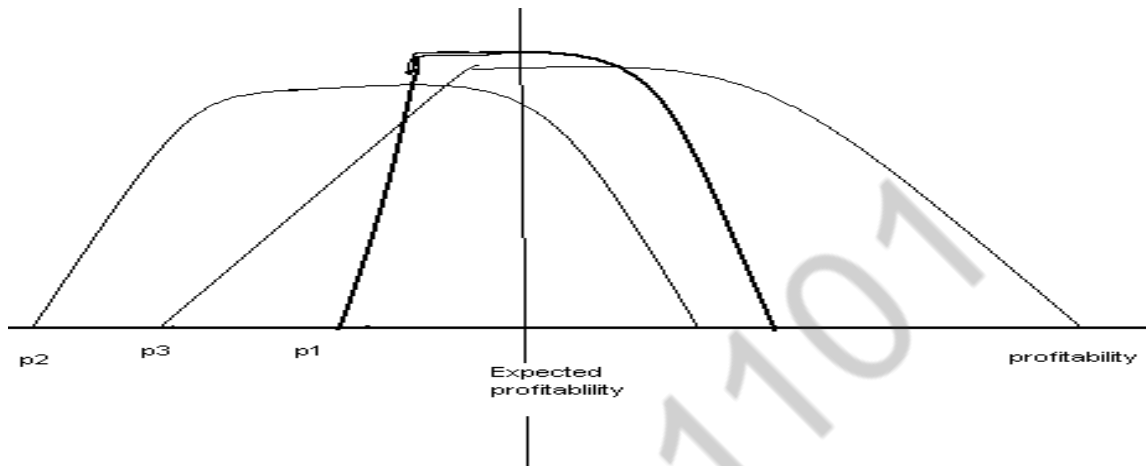

9 Explain decision trees with examples. (May 15)

Decision tree

Decision tree provide tools for evaluating expected outcomes and choosing between alternate strategies. A decision tree is a decision support tool that uses a tree-like graph or model of decisions and their possible consequences, including chance event outcomes, resource costs, and utility. It is one way to display an algorithm.

Decision trees method for risk evaluation:-

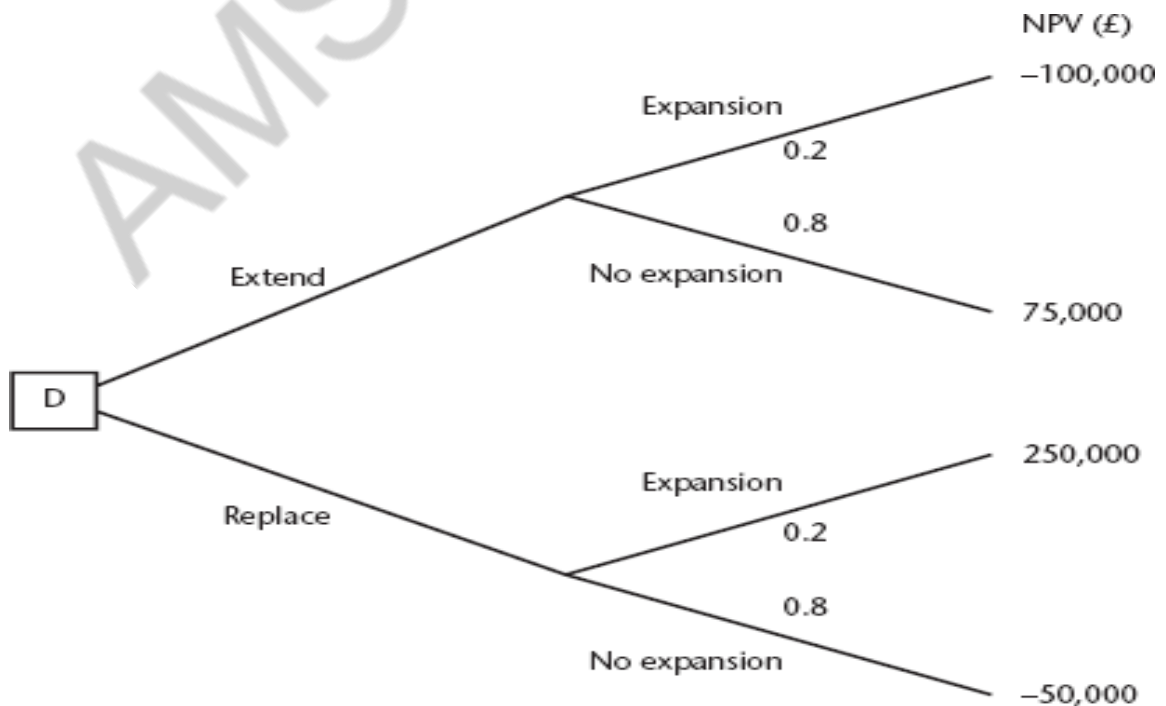

1. Amanda is responsible for extending the invoicing system.
2. An alternative would be to replace the whole of the system.
3. The decision is influenced by the likelihood of org expanding their market.
4. There is a strong rumor that they could benefit from their main competitor going out of business: in this case they could pick up a huge amount of new business, but the invoicing system could not cope.
5. However replacing the system immediately would mean other important projects would have to be delayed.
6. The NPV of extending the invoicing system is assessed as £75,000 if there is no sudden expansion.
7. If there were a sudden expansion then there would be a loss of £100,000.
8. If the whole system were replaced and there was a large expansion there would be a NPV of £250,000 due to the benefits of being able to handle increased sales.
9. If sales did not increase then the NPV would be -£50,000.
10. The decision tree shows these possible outcomes and also shows the estimated probability of each outcome.
11. The value of each outcome is the NPV multiplied by the probability of its occurring.
12. The value of a path that springs from a particular decision is the sum of the values of the possible outcomes from that decision. If it is decided to extend the system the sum of the values of the outcomes is £40,000 ($75,000 \times 0.8 - 100,000 \times 0.2$) while for replacement it would be £10,000 ($250,000 \times 0.2 - 50,000 \times 0.80$).
13. Extending the system therefore seems to be best option.

10 Explain in detail about strategic program management/ List out the types of critical risks in project planning (Nov/Dec 2018)

Strategic Programmes

Strategic planning is an organization's process of defining its strategy, or direction, and making decisions on allocating its resources to pursue this strategy. In order to determine the direction of the organization, it is necessary to understand its current position and the possible avenues through which it can pursue a particular course of action. Strategic programming makes sense when the world is expected to hold still or change predictably while the intended strategies unfold, so that formulation can logically precede implementation.

Strategic Project Management

Strategic Project Management (SPM) (also called Enterprise Project Management by some) has been defined by Callahan & Brooks (2004) as “the use of the appropriate project management knowledge, skills, tools and techniques in the context of the companies goals and objectives so that the project deliverables will contribute to company value in a way that can be measured”. Strategic Project Management is really nothing more than picking the right projects for the organization to ensure optimal returns. This sounds very simple and straightforward, but research shows that there are many organizations that have overlooked the important fact of aligning projects with corporate strategy. Strategy is a pattern in a stream of explicit and implicit strategic projects designed to create a specific competitive positioning.

The Process of Strategic Project Management

Now that we know that the goal of strategic project management is to take a project from start to finish in ways that are competitive and efficient, let's look at the process. The following are strategies a project manager, such as Kara, can use to push an

ordinary project to an extraordinary project.

1. Know the direction of the project Before starting the project, Kara fully outlines the project objectives and identifies how the project will help the company's efficiency and competitiveness as a whole. She determines who has the most at stake in this project, plans a completion timeline, and develops a reliable budget.

Once Kara has completed these steps, she lets management know what the project will accomplish, in this case, creation of a new Christmas doughnut. She makes sure everyone understands why the project is important to the company, namely, to boost holiday sales and test new efficiency techniques. Then she lays out the expected timeline and budget to complete the project successfully.

2. Explain responsibilities For her next step, Kara creates an ideal project team by gathering employees with qualities that are essential for the project. In this case, such qualities include visual creativity and efficiency, so that the product stays on track, is completed in time for the holidays, and gives the company an edge over its competitors. She consults with her boss to better understand the qualities certain employees offer and how those qualities align with the overall goal of the project. She then meets with the selected employees to explain the project and responsibilities and to make assignments based on interests and strengths.

Creating a project team specifically based on strengths and interests is an approach Kara hopes will make this project a superstar and be a work assignment technique the company can use after the holiday season.

3. Project planning During this stage, Kara outlines the steps and tasks of the project. This means she aligns each step with the timeline so that everyone on the team is aware of when each step needs to be completed. As she outlines the steps and tasks, Kara also focuses on what each employee does best so that an outstanding project is completed and the company's efficiency, quality, and competitiveness improve.

This is also the time when Kara decides how much money will be spent on each task or responsibility. The less money spent, the more profit there is, thus helping the company stay competitive with other businesses in the industry. So when Kara assigns the tasks to her team, she lets each person know when she expects the tasks to be completed.

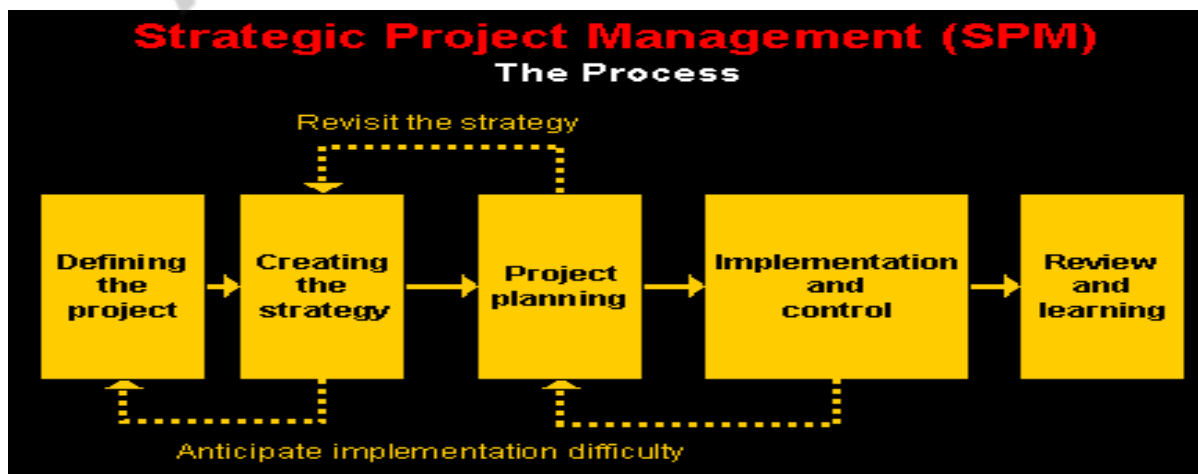

AMSCCE - 1101

The Relevance of Strategic Thinking to Project Management

Strategic thinking is typically associated with 'very big picture' thinking, or 'helicopter thinking' It is relevant to project management at a number of levels.

1. Business projects often materialize as a result of formal or informal strategy development. Besides projects which are of a corporate development and external nature, there are frequently internal projects which are aimed at reaping major organizational change.
2. Individual business projects which have materialized on a 'bottom-up' basis. Each project of that kind then needs to be linked back up to the business strategy. This should be accomplished by teasing out the strategic objectives of each and every major project.
3. Within the project itself: each and every project has both an internal environment and also some strategy for achieving its own, inherent advantage.

11 Explain the step-wise project planning in detail with suitable Flowchart.
(Dec 11,12,14,19 May 12,13,14,15, 19)

AMSCCE - 1101

Step	Activities within step
0	Select project
1	Identify project scope and objectives 1.1 Identify objectives and measures of effectiveness in meeting them 1.2 Establish a project authority 1.3 Identify stakeholders 1.4 Modify objectives in the light of stakeholder analysis 1.5 Establish methods of communication with all parties
2	Identify project infrastructure 2.1 Establish relationship between project and strategic planning 2.2 Identify installation standards and procedures 2.3 Identify project team organization
3	Analyse project characteristics 3.1 Distinguish the project as either objective- or product-driven 3.2 Analyse other project characteristics 3.3 Identify high-level project risks 3.4 Take into account user requirements concerning implementation 3.5 Select general life-cycle approach 3.6 Review overall resource estimates
4	Identify project products and activities 4.1 Identify and describe project products (including quality criteria) 4.2 Document generic product flows 4.3 Recognize product instances 4.4 Produce ideal activity network 4.5 Modify ideal to take into account need for stages and checkpoints
5	Estimate effort for each activity 5.1 Carry out bottom-up estimates 5.2 Revise plan to create controllable activities
6	Identify activity risks 6.1 Identify and quantify activity-based risks 6.2 Plan risk reduction and contingency measures where appropriate 6.3 Adjust plans and estimates to take account of risks
7	Allocate resources 7.1 Identify and allocate resources 7.2 Revise plans and estimates to take account of resource constraints
8	Review/publicize plan 8.1 Review quality aspects of project plan 8.2 Document plans and obtain agreement
9/10	Execute plan/lower levels of planning This may require the reiteration of the planning process at a lower level

Step 1: Identify project scope and objectives.

Project objectives, Project authorities, and Modified project objectives.

Step 2: Identify project Infra structure.

Role of existing strategic plans, identifying standards, project organization.

Step 3: Analyze project characteristics, High-level risks.

Step 4: Identify project products and activities, Product break down structure, IOE has standard PFD, Identifying product instances, Activity network for IOE Maintenance Accounts.

Step 5: Estimate effort for each activity, IOE Maintenance Group Accounts- breaking activities down into manageable tasks.

Step 6: Identify activity risks.

Identifying risks for Amanda

Step 7: Allocate Resources.

Taking resource constraints into account,

Step 8: Review/Publicize plan

IOE existing quality standards

Step 9 & 10: Execute plan and lower levels of planning, lower level planning for

individual modules.

AMSCCE - 1101

UNIT II PROJECT LIFE CYCLE AND EFFORT ESTIMATION

Software process and Process Models - Choice of Process models - mental delivery - Rapid Application development - Agile methods - Extreme Programming - SCRUM - Managing interactive processes - Basics of Software estimation - Effort and Cost estimation techniques - COSMIC Full function points - COCOMO II A Parametric Productivity Model - Staffing Pattern.

PART-A

1	<p>What is a software process model?</p> <p>A Process Model describes the sequence of phases for the entire lifetime of a product. Therefore it is sometimes also called Product Life Cycle. This covers everything from the initial commercial idea until the final de-installation or disassembling of the product after its use.</p>
2	<p>What were the phases in software process model?</p> <p>There are three main phases:</p> <ul style="list-style-type: none"> ✓ Concept phase ✓ Implementation phase ✓ Maintenance phase <p>Each of these main phases usually has some sub-phases, like a requirement engineering phase, a design phase, a build phase and a testing phase. The sub-phases may occur in more than one main phase each of them with a specific peculiarity depending on the main phase.</p>
3	<p>List various software process models.</p> <p>Waterfall model, Spiral model, V-model, Iterative model, Agile model and RAD model.</p>
4	<p>Define RAD/Expand RAD. Is it incremental model? Justify. (Nov/Dec 18,19)</p> <p>RAD model is Rapid Application Development model. It is a type of incremental model. In RAD model the components or functions are developed in parallel as if they were mini projects. The developments are time boxed, delivered and then assembled into a working prototype.</p>
5	<p>Write down the major aims of the RAD model.</p> <ul style="list-style-type: none"> ✓ To decrease the time taken and the cost incurred to develop software systems. ✓ To limit the cost of accommodating change requests by incorporating them as early as possible before large investments have been made on development and testing.
6	<p>What are the phases in the rapid application development (RAD) model?</p> <ul style="list-style-type: none"> ✓ Business modeling ✓ Data modeling ✓ Process modeling ✓ Application generation ✓ Testing and turnover

7	<p>What are the advantages of the RAD model? (Apr 19)</p> <ul style="list-style-type: none">✓ Reduced development time.✓ Increases reusability of components✓ Quick initial reviews occur✓ Encourages customer feedback✓ Integration from very beginning solves a lot of integration issues.
---	---

AMSCCE - 1101

8	<p>Define Agile Methods.</p> <ul style="list-style-type: none"> ✓ Agile model is a combination of iterative and incremental process models with focus on process adaptability and customer satisfaction by rapid delivery of working software product. ✓ Agile Methods break the product into small incremental builds. These builds are provided in iterations. Every iteration involves cross functional teams working simultaneously on various areas like planning, requirements analysis, design, coding, unit testing, and acceptance testing.
9	<p>List out the various agile approaches.</p> <ul style="list-style-type: none"> ✓ Crystal Technologies ✓ Atern(formerly DSDM) ✓ Feature-driven Development ✓ Scrum ✓ Extreme Programming(XP)
10	<p>What is extreme programming?</p> <p>Extreme programming (XP) is a software development methodology, which is intended to improve software quality and responsiveness to changing customer requirements. As a type of agile software development, it advocates frequent "releases" in short development cycles, to improve productivity and introduce checkpoints at which new customer requirements can be adopted.</p>
11	<p>List the fundamental principles of extreme programming?</p> <p>The fundamental principles of Extreme Programming are Rapid feedback, Assume simplicity, Incremental change, Embracing change and Quality work.</p>
12	<p>What are the values of extreme programming?</p> <p>Extreme Programming (XP) is based on the five values</p> <ul style="list-style-type: none"> ✓ Communication ✓ Simplicity ✓ Feedback ✓ Courage ✓ Respect
13	<p>What are the limitations of extreme programming?</p> <ul style="list-style-type: none"> ✓ This becomes difficult where developers and users belong to different organizations. ✓ Development staff needs to be physically located in the same office. ✓ Communication problems if the application does not have a visual interface. ✓ Large, complex systems may initially need significant architectural effort. This might preclude the use of XP.

14	<p>What is SCRUM? (Apr 18, Dec 18,19)</p> <ul style="list-style-type: none">✓ Scrum is an efficient framework within which you can develop software with teamwork. It is based on agile principles.✓ Scrum supports continuous collaboration among the customer, team members, and relevant stakeholders.
----	---

AMSCCE - 1101

15	<p>Define software estimation. Estimation techniques are of utmost importance in software development life cycle, where the time required to complete a particular task is estimated before a project begins. Estimation is the process of finding an estimate, or approximation, which is a value that can be used for some purpose even if input data may be incomplete, uncertain, or unstable.</p>							
16	<p>List out steps in software estimation. (Apr 19) The four basic steps in Software Project Estimation are</p> <ul style="list-style-type: none"> ✓ Estimate the size of the development product. ✓ Estimate the effort in person-months or person-hours. ✓ Estimate the schedule in calendar months. ✓ Estimate the project cost in agreed currency. 							
17	<p>What are software effort estimation techniques?</p> <ul style="list-style-type: none"> ✓ Algorithm models ✓ Expert judgment ✓ Analogy ✓ Parkinson ✓ Price to win ✓ Top-down ✓ Bottom-up 							
18	<p>Distinguish between Bottom-up and Top-Down estimate.</p> <table border="1" data-bbox="197 1048 1469 1227"> <thead> <tr> <th data-bbox="197 1048 836 1093">Bottom-up</th> <th data-bbox="836 1048 1469 1093">Top-down</th> </tr> </thead> <tbody> <tr> <td data-bbox="197 1093 836 1137">Use when no past project data</td> <td data-bbox="836 1093 1469 1137">Based on past project data</td> </tr> <tr> <td data-bbox="197 1137 836 1227">Identify all tasks that have to be done – so quite time-consuming</td> <td data-bbox="836 1137 1469 1227">Divide overall estimate between jobs to be done</td> </tr> </tbody> </table>		Bottom-up	Top-down	Use when no past project data	Based on past project data	Identify all tasks that have to be done – so quite time-consuming	Divide overall estimate between jobs to be done
Bottom-up	Top-down							
Use when no past project data	Based on past project data							
Identify all tasks that have to be done – so quite time-consuming	Divide overall estimate between jobs to be done							
19	<p>Define COSMIC Full function points.</p> <ul style="list-style-type: none"> ✓ COSMIC FFP – Common Software Measurement Consortium Full Function Point. ✓ COSMIC deals with decomposing the system architecture into a hierarchy of software layers. ✓ Unit is Cfsu(COSMIC functional size units). 							
20	<p>Write about COCOMO model.</p> <ul style="list-style-type: none"> ✓ Constructive Cost Model. ✓ It refers to a group of models. ✓ The basic model was built around the equation: $\text{Effort} = c * \text{size}^k,$ ✓ Where effort is measured in pm, or the number of ‘person-months’. 							
21	<p>Define organic mode. Organic mode is the case when relatively small teams developed software in a highly familiar in-house environment and when the system being developed was small and the interface requirements were flexible.</p>							

22	Define application composition. In application composition the external features of the system that the users will experience are designed. Prototyping will typically be employed to do this. With small application that can be built using high-productivity application building tools, development can stop at this point.
----	---

AMSCCE - 1101

23	<p>List the steps of estimate effort.</p> <p>Step 1: Use Wideband Delphi Technique to construct WBS. We suggest that the tasks should not be more than 8 hrs. If a task is of larger duration, split it.</p> <p>Step 2: Use Wideband Delphi Technique or Three-point Estimation to arrive at the Effort Estimates for the Tasks.</p>
24	<p>Give an idea about parametric model?</p> <ul style="list-style-type: none"> ✓ Models that focus on task or system size. Eg.Function Points. ✓ FPs originally used to estimate Lines of Code, rather than effort <div data-bbox="212 477 1350 819" style="border: 1px solid black; padding: 5px; margin: 10px 0;"> </div> <ul style="list-style-type: none"> ✓ Models that focus on productivity: e.g. COCOMO ✓ In this Lines of code (or FPs etc) is an input <div data-bbox="212 904 1350 1205" style="border: 1px solid black; padding: 5px; margin: 10px 0;"> </div>
25	<p>What is the use of COCOMO model and its types?</p> <p>COCOMO predicts the effort and schedule for a software product development based on inputs relating to the size of the software and a number of cost drivers that affect productivity.</p> <p>COCOMO has three different models that reflect the complexity:</p> <ul style="list-style-type: none"> ✓ The Basic Model ✓ The Intermediate Model ✓ The Detailed Model
26	<p>Write any two advantages of function point analysis.(Dec 11)</p> <ul style="list-style-type: none"> ✓ Improved project estimating ✓ Understanding project and maintenance productivity ✓ Managing changing project requirements ✓ Gathering user requirements.
PART-B	
1	<p>Discuss in detail about software process and process models. (Apr 19)</p> <p>A software process is a set of activities that leads to the production of a software product. These activities may involve the development of software from scratch in a standard programming language like Java or C. Increasingly, however, new software is developed by extending and modifying existing systems and by configuring and</p>

integrating off-the-shelf software or system components.

Software processes are complex and, like all intellectual and creative processes, rely on people making decisions and judgments. Because of the need for judgement and creativity, attempts to automate software processes have met with limited success. Computer-aided software engineering (CASE) tools can support some process activities. However, there is no possibility, at least in the next few years, of more extensive automation where software takes over creative design from the engineers involved in the software process.

Although there are many software processes, some fundamental activities are common to all software processes:

1. Software specification the functionality of the software and constraints on its operation must be defined.
2. Software design and implementation the software to meet the specification must be produced.
3. Software validation the software must be validated to ensure that it does what the customer wants.
4. Software evolution the software must evolve to meet changing customer needs.

Software process models

The waterfall model

- ❖ Plan-driven model. Separate and distinct phases of specification and development.
- ❖ Incremental development
- ❖ Specification, development and validation are interleaved. May be plan-driven or agile.
- ❖ Reuse-oriented software engineering
- ❖ The system is assembled from existing components. May be plan-driven or agile.

In practice, most large systems are developed using a process that incorporates elements from all of these models.

The waterfall model

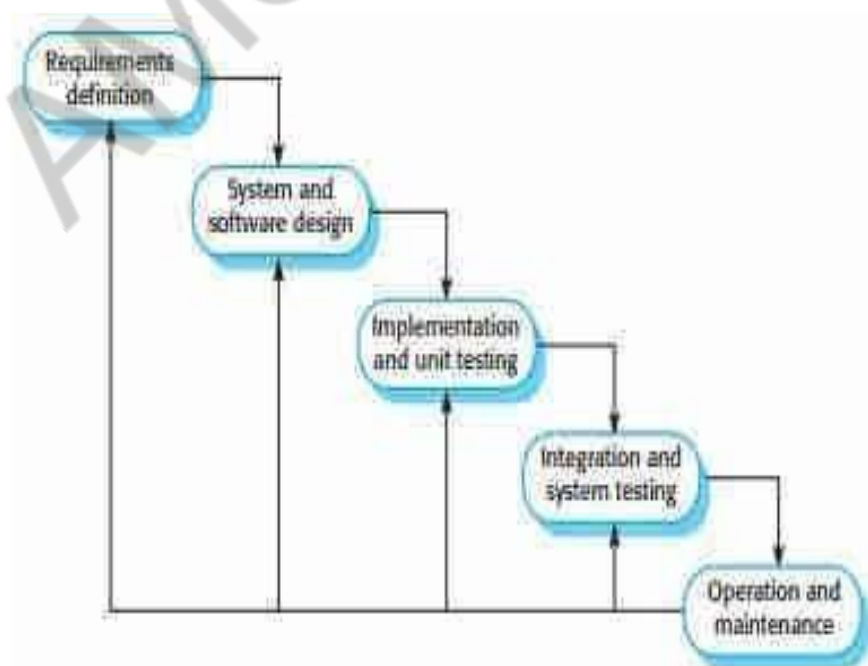

AMSCCE - 1101

Fundamental development activities:

1. Requirements analysis and definition The system's services, constraints and goals are, established by consultation with system users. They are then defined in detail and serve as a system specification.
2. System and software design the systems design process partitions the requirements to either hardware or software systems. It establishes overall system architecture. Software design involves identifying and describing the fundamental software system abstractions and their relationships.
3. Implementation and unit testing during this stage, the software design is realized as a set of programs or program units. Unit testing involves verifying that each unit meets its specification.
4. Integration and system testing the individual program units or programs are integrated and tested as a complete system to ensure that the software requirements have been met. After testing, the software system is delivered to the customer.
5. Operation and maintenance normally (although not necessarily) this is the longest life-cycle phase. The system is installed and put into practical use. Maintenance: involves correcting errors which were not discovered in earlier stages of the life cycle, improving the implementation of system units and enhancing the system's services as new requirements are discovered.

In principle, the result of each phase is one or more documents that are approved ('signed off'). The following phase: should not start until the previous phase has finished. In practice, these stages overlap and feed information to each other. During design, problems with requirements are identified; during coding design problems are found and so on. The software process is not a simple linear model but involves a sequence of iterations of the development activities.

Incremental development benefits

The cost of accommodating changing customer requirements is reduced.

- ❖ The amount of analysis and documentation that has to be redone is much less than is required with the waterfall model.
- ❖ It is easier to get customer feedback on the development work that has been done.
- ❖ Customers can comment on demonstrations of the software and see how much has been implemented.
- ❖ More rapid delivery and deployment of useful software to the customer is possible.
- ❖ Customers are able to use and gain value from the software earlier than is possible with a waterfall process.

The process is not visible.

- ❖ Managers need regular deliverables to measure progress. If systems are developed quickly, it is not cost-effective to produce documents that reflect every version of the system.
- ❖ System structure tends to degrade as new increments are added.
- ❖ Unless time and money is spent on refactoring to improve the software, regular change tends to corrupt its structure. Incorporating further software changes becomes increasingly difficult and costly.

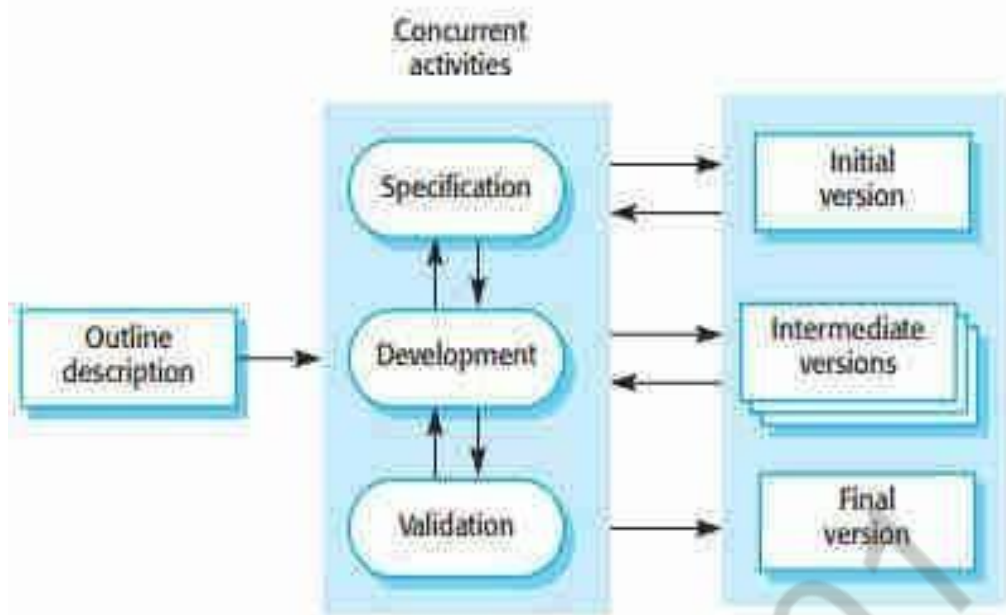

AMSCCE-110

2 Explain in detail about Rapid Application development.

Rapid Application Development model relies on prototyping and rapid cycles of iterative development to speed up development and elicit early feedback from business users. After each iteration, developers can refine and validate the features with stakeholders. RAD model is also characterized by reiterative user testing and the re-use of software components. Hence, RAD has been instrumental in reducing the friction points in delivering successful enterprise applications.

Wave Maker makes use of the RAD model to provide a Rapid Application Development platform to create web and mobile applications. The following diagram depicts Wave Maker RAD platform architecture, based on the MVC (Model-View-Controller) pattern. Open standards, easy customization and rapid prototyping are central to the platform.

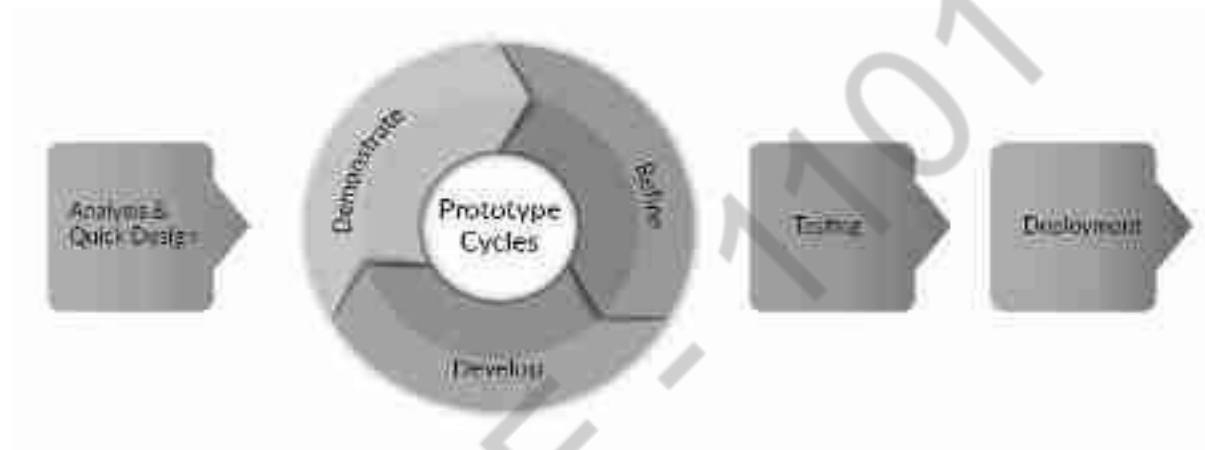
**Phases in RAD Model:**

- ❖ Business Modeling
- ❖ Data Modeling
- ❖ Process Modeling
- ❖ Application Modeling
- ❖ Testing and Turnover

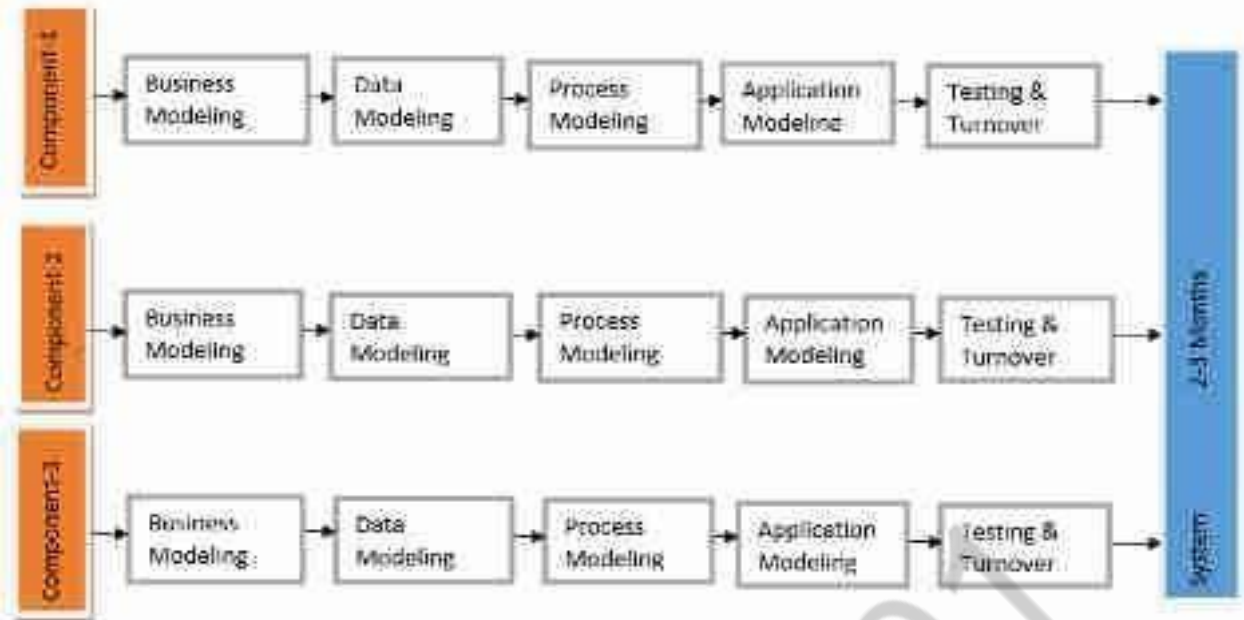

Business Modeling: In this phase of development business model should be designed based on the information available from different business activities. Before start the development there should be a complete picture of business process functionality.

Data Modeling: Once the business modeling phase over and all the business analysis completed, all the required and necessary data based on business analysis are identified in data modeling phase.

Process Modeling: All the data identified in data modeling phase are planned to process or implement the identified data to achieve the business functionality flow. In this phase all the data modification process is defined.

Application Modeling: In this phase application id developed and coding completed. With help of automation tools all data implemented and processed to work as real time.

Testing and turnover: All the testing activates are performed to test the developed application.

Advantages of RAD Model:

- ❖ Fast application development and delivery.
- ❖ Least testing activity required.
- ❖ Visualization of progress.
- ❖ Less resource required.
- ❖ Review by the client from the very beginning of development so very less chance to miss the requirements.
- ❖ Very flexible if any changes required.
- ❖ Cost effective.
- ❖ Good for small projects.

Disadvantages of RAD Model:

- ❖ High skilled resources required.
- ❖ On each development phase client's feedback required.
- ❖ Automated code generation is very costly.
- ❖ Difficult to manage.
- ❖ Not a good process for long term and big projects.

- ❖ Proper modularization of project required.

AMSCE - 1101

3 Explain about Agile methods.(Nov/Dec 18)

Agile software development methodology is a process for developing software (like other software development methodologies – Waterfall model, V-Model, Iterative model etc.) However, **Agile methodology** differs significantly from other methodologies. In English, Agile means ‘ability to move quickly and easily’ and responding swiftly to change – this is a key aspect of Agile software development as well.

Brief overview of Agile Methodology

- In traditional software development methodologies like Waterfall model, a project can take several months or years to complete and the customer may not get to see the end product until the completion of the project.
- At a high level, non-Agile projects allocate extensive periods of time for Requirements gathering, design, development, testing and UAT, before finally deploying the project.
- In contrast to this, Agile projects have Sprints or iterations which are shorter in duration (Sprints/iterations can vary from 2 weeks to 2 months) during which pre-determined features are developed and delivered.
- Agile projects can have one or more iterations and deliver the complete product at the end of the final iteration.

Example of Agile software development

Example: Google is working on project to come up with a competing product for MS Word, that provides all the features provided by MS Word and any other features requested by the marketing team. The final product needs to be ready in 10 months of time. Let us see how this project is executed in traditional and Agile methodologies.

In traditional Waterfall model –

- At a high level, the project teams would spend 15% of their time on gathering requirements and analysis (1.5 months)
- 20% of their time on design (2 months)
- 40% on coding (4 months) and unit testing
- 20% on System and Integration testing (2 months).
- At the end of this cycle, the project may also have 2 weeks of User Acceptance testing by marketing teams.
- In this approach, the customer does not get to see the end product until the end of the project, when it becomes too late to make significant changes.

project schedule in traditional software development.

With **Agile development** methodology –

- In the **Agile methodology**, each project is broken up into several ‘Iterations’.
- All Iterations should be of the same time duration (between 2 to 8 weeks).
- At the end of each iteration, a working product should be delivered.
- In simple terms, in the Agile approach the project will be broken up into 10 releases (assuming each iteration is set to last 4 weeks).
- Rather than spending 1.5 months on requirements gathering, in Agile software development, the team will decide the basic core features that are required in the

product and decide which of these features can be developed in the first

AMSCCE - 1101

iteration.

- Any remaining features that cannot be delivered in the first iteration will be taken up in the next iteration or subsequent iterations, based on priority.
- At the end of the first iterations, the team will deliver a working software with the features that were finalized for that iteration.

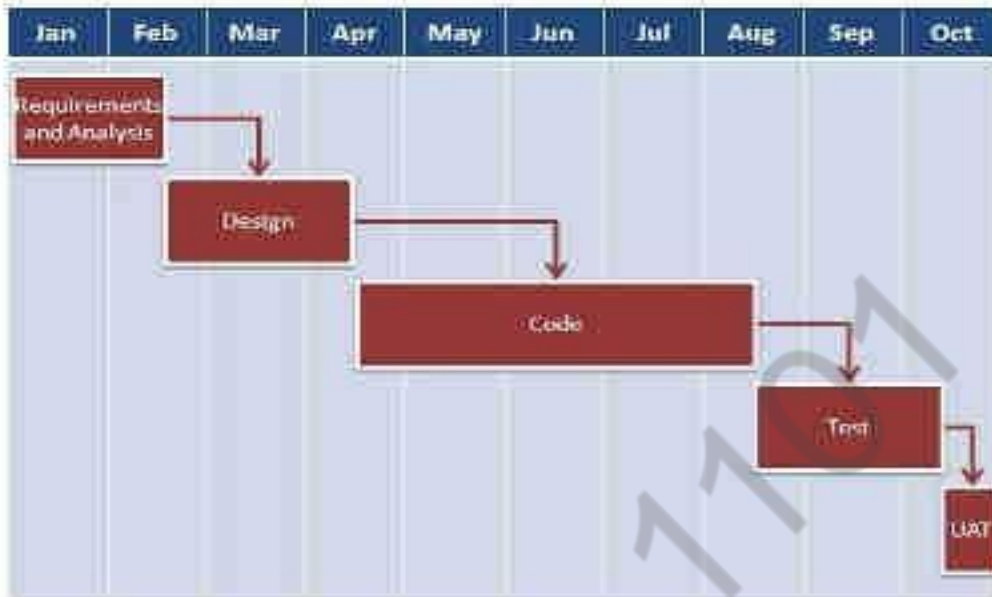

There will be 10 iterations and at the end of each iteration the customer is delivered a working software that is incrementally enhanced and updated with the features that were shortlisted for that iteration.

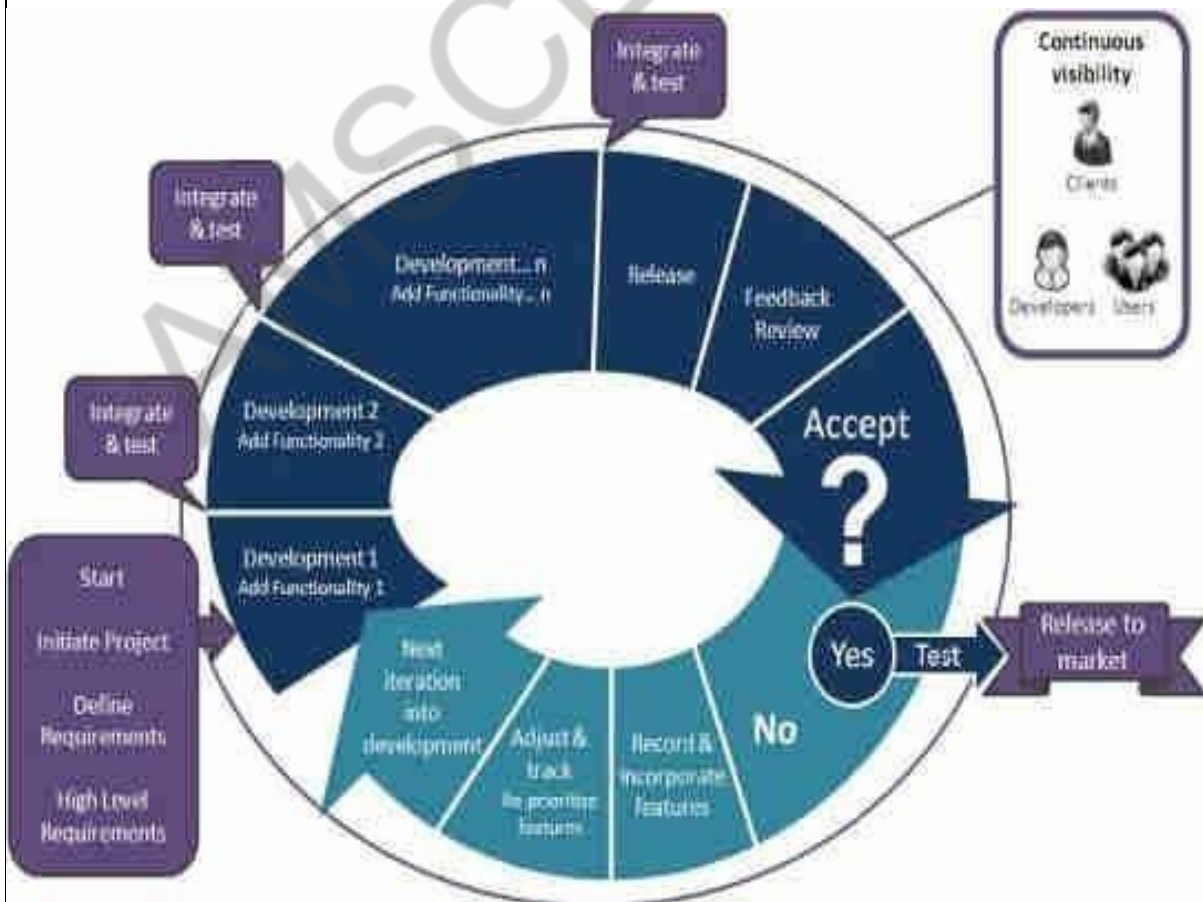

AMSCCE - 1101

4 List the role and principles of extreme programming. (Apr 18)

Extreme Programming technique is very helpful when there is constantly changing demands or requirements from the customers or when they are not sure about the functionality of the system. It advocates frequent "releases" of the product in short development cycles, which inherently improves the productivity of the system and also introduces a checkpoint where any customer requirements can be easily implemented. The XP develops software keeping customer in the target.

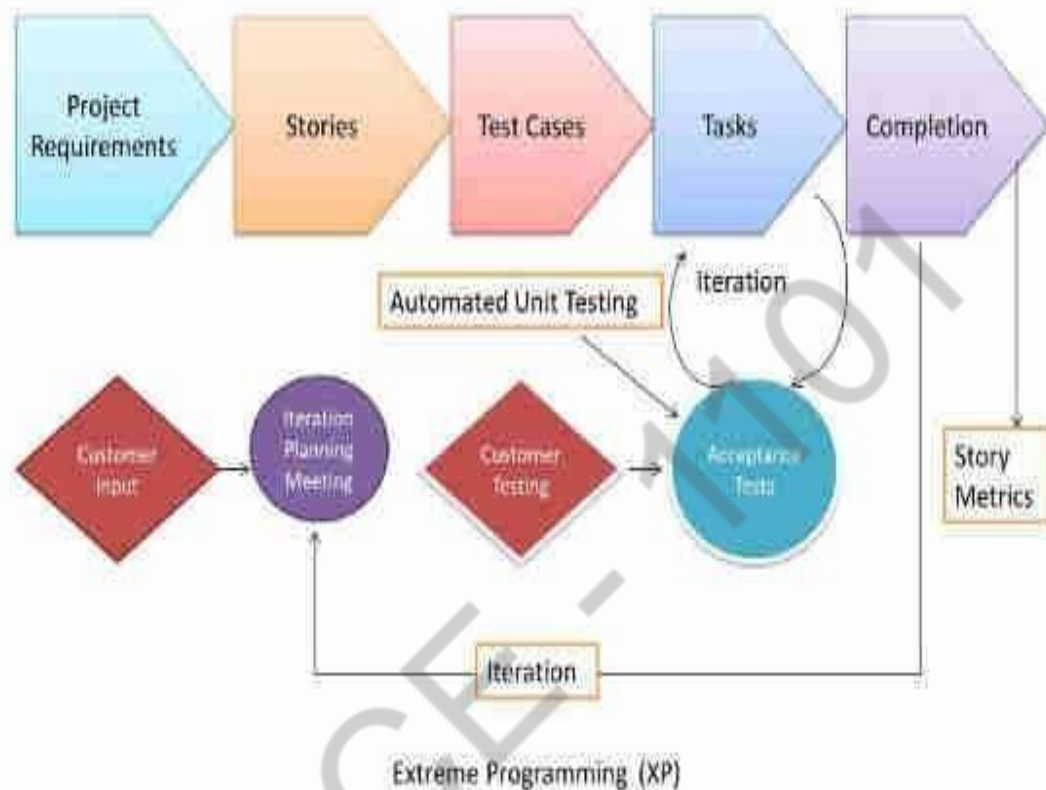

Phases of extreme programming:

There are 6 phases available in Agile XP method, and those are explained as follows:

Planning

- ❖ Identification of stakeholders and sponsors
- ❖ Infrastructure Requirements
- ❖ Security related information and gathering
- ❖ Service Level Agreements and its conditions

Analysis

- ❖ Capturing of Stories in Parking lot
- ❖ Prioritize stories in Parking lot
- ❖ Scrubbing of stories for estimation
- ❖ Define Iteration SPAN(Time)
- ❖ Resource planning for both Development and QA teams

Design

- ❖ Break down of tasks
- ❖ Test Scenario preparation for each task
- ❖ Regression Automation Framework

Execution

- ❖ Coding
- ❖ Unit Testing

- ❖ Execution of Manual test scenarios

AMSCE - 1101

- ❖ Defect Report generation
- ❖ Conversion of Manual to Automation regression test cases
- ❖ Mid Iteration review
- ❖ End of Iteration review

Wrapping

- ❖ Small Releases
- ❖ Regression Testing
- ❖ Demos and reviews
- ❖ Develop new stories based on the need
- ❖ Process Improvements based on end of iteration review comments

Closure

- ❖ Pilot Launch
- ❖ Training
- ❖ Production Launch
- ❖ SLA Guarantee assurance
- ❖ Review SOA strategy
- ❖ Production Support

There are two storyboards available to track the work on a daily basis, and those are listed below for reference.

Story Cardboard

- ❖ This is a traditional way of collecting all the stories in a board in the form of stick notes to track daily XP activities. As this manual activity involves more effort and time, it is better to switch to an online form.

Online Storyboard

- ❖ Online tool Storyboard can be used to store the stories. Several teams can use it for different purposes.

Roles

Customer

- ❖ Writes User Stories and specifies Functional Tests
- ❖ Sets priorities, explains stories
- ❖ May or may not be an end-user
- ❖ Has authority to decide questions about the stories !

Programmer

- ❖ Estimates stories
- ❖ Defines Tasks from stories, and estimates
- ❖ Implements Stories and Unit Tests

Coach

- ❖ Watches everything, makes sure the project stays on course
- ❖ Helps with anything

Tracker

- ❖ Monitors Programmers progress, takes action if things seem to be going off track.
- ❖ Actions include setting up a meeting with Customer, asking Coach or another Programmer to help

Tester

- ❖ Implements and runs Functional Tests (not Unit Tests!)
- ❖ Graphs results, and makes sure people know when test results decline.

Doomsayer

- ❖ Ensures that everybody knows the risks involved

- ❖ Ensures that bad news isn't hidden, glossed over, or blown out of proportion

AMSCE - 1101

Manager

- ❖ Schedules meetings (e.g. Iteration Plan, Release Plan), makes sure the meeting process is followed, records results of meeting for future reporting, and passes to the Tracker
- ❖ Possibly responsible to the Gold Owner.
- ❖ Goes to meetings, brings back useful information

Gold Owner

- ❖ The person funding the project, which may or may not be the same as the Customer

AMSCCE - 1101

5 **What is SCRUM? Explain.**

SCRUM is an agile development method which concentrates specifically on how to manage tasks within a team based development environment. Basically, Scrum is derived from activity that occurs during a rugby match. Scrum believes in empowering the development team and advocates working in small teams (say- 7 to 9 members).

It consists of three roles, and their responsibilities are explained as follows

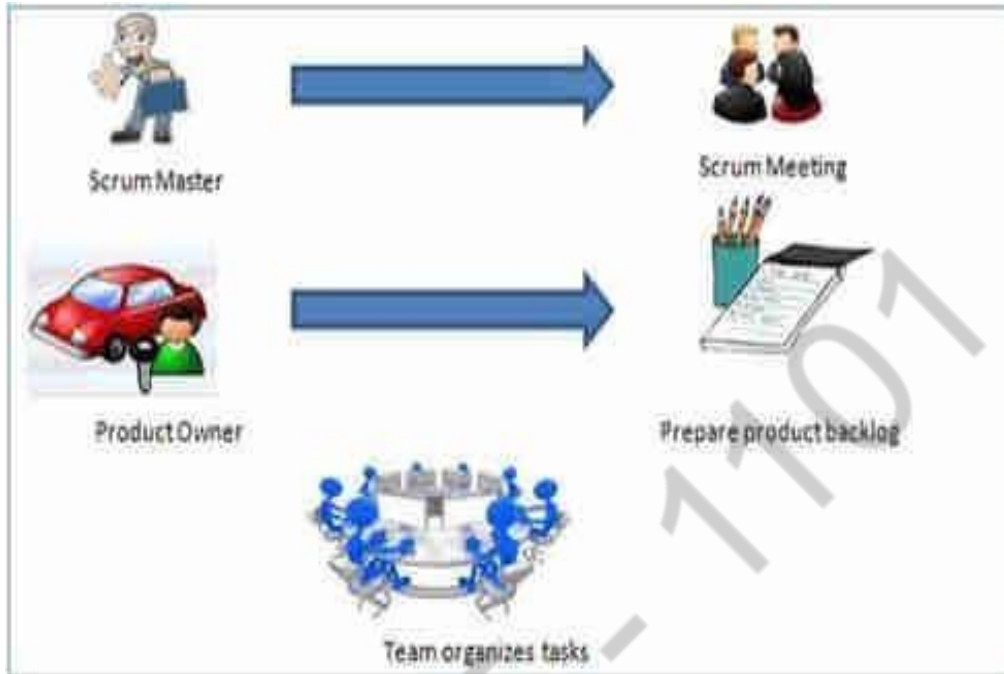
**Scrum Master**

Master is responsible for setting up the team, sprint meeting and removes obstacles to progress

Product owner

The Product Owner creates product backlog, prioritizes the backlog and is responsible for the delivery of the functionality at each iteration

Scrum Team

Team manages its own work and organizes the work to complete the sprint or cycle

Product Backlog

This is a repository where requirements are tracked with details on the no of requirements to be completed for each release. It should be maintained and prioritized by product owner, and it should be distributed to the scrum team. Team can also request for a new requirement addition or modification or deletion

Scrum Practices

Practices are described in detailed:

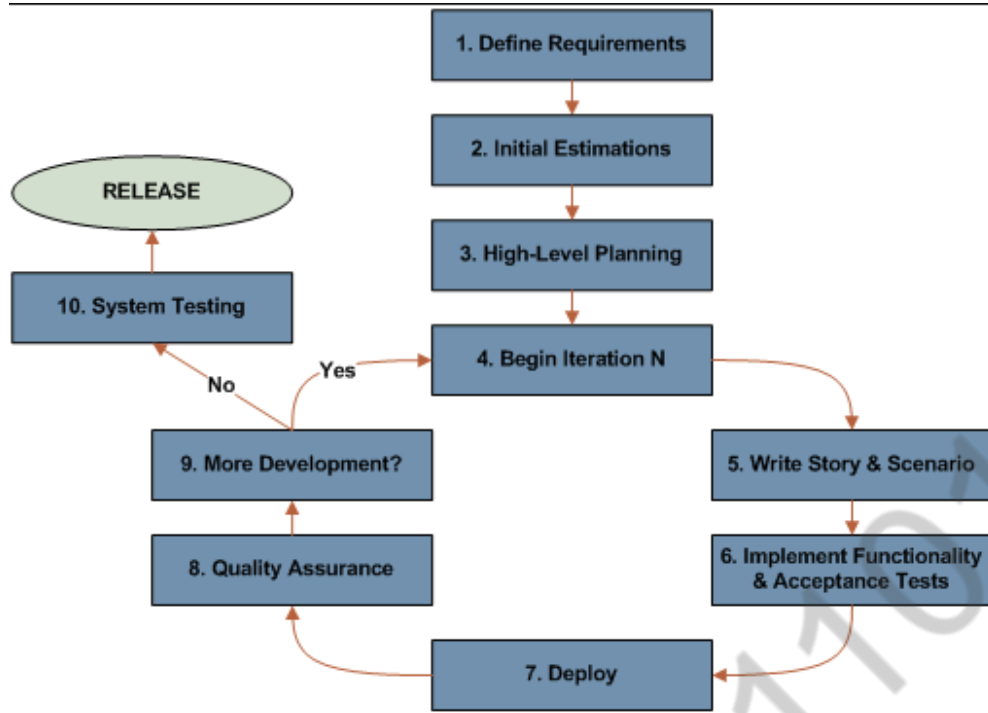

Process flow of Scrum:

Process flow of scrum testing is as follows:

- Each iteration of a scrum is known as Sprint
- Product backlog is a list where all details are entered to get end product
- During each Sprint, top items of Product backlog are selected and turned into Sprint backlog
- Team works on the defined sprint backlog
- Team checks for the daily work
- At the end of the sprint, team delivers product functionality

6	<p>Explain in detail about Managing interactive processes.</p> <p>Models are defined as explicit representations of some portions of reality as perceived by some actor. A model is active if it influences the reality it reflects; if changes to the representation also change the way some actors perceive reality. Model activation is the process by which a model affects reality. Activation involves actors interpreting the model and adjusting their behavior to it. This process can be Automated, where a software component executes the model, Manual, where the model guides the actions of human actors, or Interactive, where prescribed aspects of the model are automatically interpreted and ambiguous parts are left to the users to resolve, with tool support. Fully automated activation implies that the model must be formal and complete, while manual and interactive activation also can handle informal and evolving models. We define a model to be interactive if it is interactively activated. The process of defining and updating an interactive model is called articulation. In this</p>
---	---

thesis we are primarily concerned with interactive models of work processes. By altering models of their own work, users can control and customize the behavior of an interactive system. The inter-play of articulation and activation (Figure 2) keeps the models alive and up to date as resources for learning, coordination and work support. The three engineering challenges (articulation, activation, and reuse) all contribute to increasing the benefits of interactive models and decreasing the efforts and learning required to use the system.

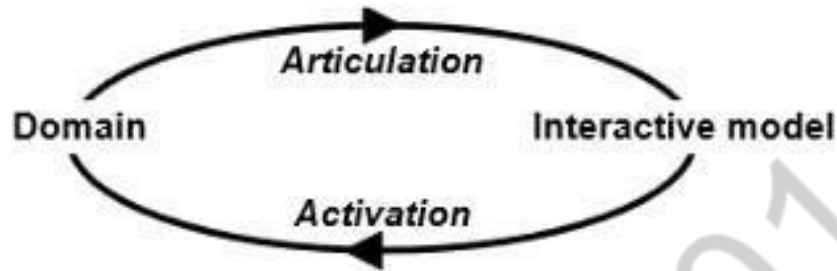

Figure 2. The interplay of articulation and activation.

The Potential of Interactive Process Models

The constantly changing nature of the competitive environment in the global network economy creates emergent organizations, where "every feature of social organization culture, meaning, social relationships, decision processes and so on are continually emergent, following no predefined pattern". This environment requires evolving information systems, adapting their behavior to updated models of the usage environment.

Articulation: Simple and User-Oriented Process Modeling

Our approach relies on the assumption that end users must be actively involved in creating, updating and interpreting models of their own work, as part of the work. Local participants are the only ones with sufficient knowledge of the process. Modeling by end users has met skepticism from the workflow research community. On the other hand, studies of user participation in IS development, tailoring, knowledge management and process improvement indicate that our approach is viable. In workflow management, users also deal creatively with change and exceptions, often by taking the process out of the system and handling it manually. Systems not designed for user involvement thus present a barrier to local innovation, and are unable to capture these contributions for further assessment and knowledge management. End user participation remains primarily an organizational problem, involving trust, power and community building, but simple, user-oriented, and adaptable modeling languages will remove many barriers.

Activation: Customized and Integrated Software Support

Simple and useful tools motivate use. Information systems that offer a wide range of functionality often become overwhelmingly complex and incomprehensible. Consequently, only a small portion of the available functionality is utilized. This condition is known as featurisms. We need role and task specific user

interfaces, containing just what is needed in the current context.

AMSCCE - 1101

	containing just what is needed in the current context. Interfaces and semantics should
--	--

AMSCCE - 1101

also adapt to the local needs of each project. Process models, articulating who performs which tasks when and why, is a powerful resource for such customization. Systems and processes should also adapt to the skills and preferences of each individual. Personalization fosters a sense of ownership, further motivating active participation.

In virtual enterprises, the unique nature of each project, and the changing set of partners, seldom makes it economically viable to integrate information systems through conventional development methods. Standardization requires that the domain is static and well understood, and is thus seldom appropriate for knowledge work. Consequently, we need a flexible infrastructure that allows shared understanding and semantic interoperability to emerge from the project, rather than being a prerequisite for cooperation. Interactive models provide a simple, visual approach to capture shared understanding as it unfolds.

Reuse: Process Knowledge Management

The gap between what people say and what they do, makes it difficult to use plans and other official descriptions of work as input to KM . Local articulation of process models must thus be straightforward, but still some knowledge cannot be modeled and will remain tacit. Process models will thus be incomplete while they are used, subject to an ongoing elaboration and interpretation. Models are completed only when they are no longer in use. Interactive modeling allows the system to handle incomplete, evolving descriptions of work, by involving users in resolving incompleteness and inconsistencies during activation. The openness of the approach allows local process innovation to be captured, assessed and packaged for reuse in similar future projects.

7	<p>Discuss in detail about basics of software estimation. (Apr 19)</p> <p>The four basic steps in software project estimation are:</p> <ol style="list-style-type: none">1) Estimate the size of the development product. This generally ends up in either Lines of Code (LOC) or Function Points (FP), but there are other possible units of measure. A discussion of the pros & cons of each is discussed in some of the material referenced at the end of this report.2) Estimate the effort in person-months or person-hours.3) Estimate the schedule in calendar months.4) Estimate the project cost in dollars (or local currency) <p>Estimating size</p> <p>An accurate estimate of the size of the software to be built is the first step to an effective estimate. Your source(s) of information regarding the scope of the project should, wherever possible, start with formal descriptions of the requirements</p> <p>Two main ways you can estimate product size are:</p> <ol style="list-style-type: none">1) By analogy. Having done a similar project in the past and knowing its size, you estimate each major piece of the new project as a percentage of the size of a similar piece of the previous project. Estimate the total size of the new project by adding up the estimated sizes of each of the pieces. An experienced estimator can produce reasonably good size estimates by analogy if accurate size values are available for the previous project and if the new project is sufficiently similar to the previous one.2) By counting product features and using an algorithmic approach such as Function
---	---

Points to convert the count into an estimate of size. Macro-level “product features” may

AMSCCE - 1101

include the number of subsystems, classes/modules, methods/functions. More detailed “product features” may include the number of screens, dialogs, files, database tables, reports, messages, and so on.

Estimating effort

Once you have an estimate of the size of your product, you can derive the effort estimate. This conversion from software size to total project effort can only be done if you have a defined software development lifecycle and development process that you follow to specify, design, develop, and test the software. A software development project involves far more than simply coding the software – in fact, coding is often the smallest part of the overall effort. Writing and reviewing documentation, implementing prototypes, designing the deliverables, and reviewing and testing the code take up the larger portion of overall project effort. The project effort estimate requires you to identify and estimate, and then sum up all the activities you must perform to build a product of the estimated size.

There are two main ways to derive effort from size:

- 1) The best way is to use your organization’s own historical data to determine how much effort previous projects of the estimated size have taken.
- 2) If you don’t have historical data from your own organization because you haven’t started collecting it yet or because your new project is very different in one or more key aspects, you can use a mature and generally accepted algorithmic approach such as Barry Boehm’s COCOMO model or the Putnam Methodology to convert a size estimate into an effort estimate.

Estimating schedule

The third step in estimating a software development project is to determine the project schedule from the effort estimate. This generally involves estimating the number of people who will work on the project, what they will work on (the Work Breakdown Structure), when they will start working on the project and when they will finish (this is the “staffing profile”). Once you have this information, you need to lay it out into a calendar schedule. Again, historical data from your organization’s past projects or industry data models can be used to predict the number of people you will need for a project of a given size and how work can be broken down into a schedule.

Estimating Cost

There are many factors to consider when estimating the total cost of a project. These include labor, hardware and software purchases or rentals, travel for meeting or testing purposes, telecommunications (e.g., long-distance phone calls, video-conferences, dedicated lines for testing, etc.), training courses, office space, and so on.

Exactly how you estimate total project cost will depend on how your organization allocates costs. Some costs may not be allocated to individual projects and may be taken care of by adding an overhead value to labor rates (\$ per hour). Often, a software development project manager will only estimate the labor cost and identify any additional project costs not considered “overhead” by the organization.

The simplest labor cost can be obtained by multiplying the project’s effort estimate (in hours) by a general labor rate (\$ per hour). A more accurate labor cost would result

from using a specific labor rate for each staff position (e.g., Technical, QA, Project

AMSCCE - 1101

Management, Documentation, Support, etc.). You would have to determine what percentage of total project effort should be allocated to each position. Again, historical data or industry data models can help.

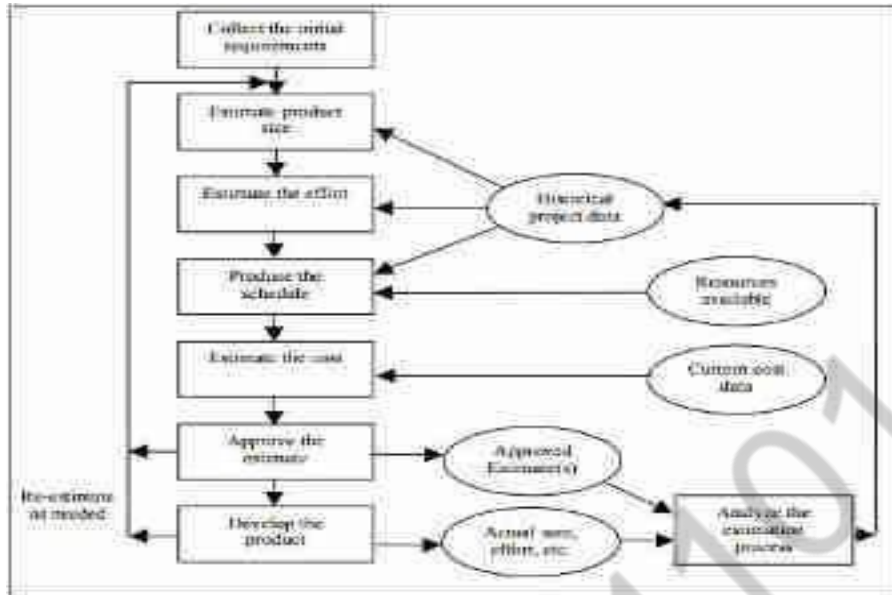

8 What are effort and cost estimation techniques? Explain in detail/Analyze the importance of COCOMO model for software estimation. (Dec 18, Apr 19)

Size Oriented Metrics

i) Source Lines of Code (SLOC): is software metric used to measure the size of software program by counting the number of lines in the text of the program's source code. This metric does not count blank lines, comment lines, and library. SLOC measures are programming language dependent. They cannot easily accommodate nonprocedural languages. SLOC also can be used to measure others, such as errors/KLOC, defects/KLOC, pages of documentation/KLOC, cost/KLOC. ii) Deliverable Source Instruction (DSI): i similar to SLOC. The difference between DSI and SLOC is that s "if-then-else" statement, it would be counted as one SLOC but might be counted as several DSI .

Function Oriented Metrics:

Function Point (FP): FP defined by Allan Albrecht at IBM in 1979, is a unit of measurement to express the amount software functionality [5]. Function point analysis (FPA) is the method of measuring the size of software. The advantage is that it can avoid source code error when selecting different programming languages. FP is programming language independent, making ideal for applications using conventional and nonprocedural languages. It is base on data that are more likely to be known early in the evolution of project.

Function types are as:

- External Inputs (EI): it originates from user or transmitted from another application.
- External Outputs (EO) : it is derived data within application that provides information to the user.
- External Enquiries (EQ) : it is online i/p that results in the generation of some immediate s/w response in the form of an online output.
- Internal Logical Files (ILF) : is logical grouping of data that resides within the

applications boundary and maintained via EI.

AMSCCE - 1101

- External Interface Files (EIF) : is logical grouping of data that resides external to application but provides information that may be of use to the application.

Test Point (TP) Test point used for test point analysis (TPA), to estimate test effort for system and acceptance tests. However, it is important to note that TPA itself only covers functional testing. Hence, it is always used with FPA, that does not cover system and acceptance tests. Consequently, FPA and TPA merged together provide means for estimating both, white and black box testing efforts. There are a lot of dependent and independent factors that need to be taken into account

Test effort estimation using UCP, is based upon use cases (UC). UC is systems behavior under various conditions, based on requests from a stakeholder. UC capture contractual agreements between these stakeholders about the systems behaviour. Thus, the primary task of UCP is to map use cases (UC) to test cases (TC). Hereby, each scenario together with the corresponding exception flow for each UC serves as input for a specific TC. Basically, the amount of test cases identified through this mapping results in the corresponding test effort estimation

COCOMO (Constructive Cost Models):

This family of models proposed by Barry Boehm , is the most popular method which is categorized in algorithmic methods. This method uses some equations and parameters, which have been derived from previous experiences about software projects for estimation. The models have been widely accepted in practice. In the COCOMOs, the code-size S is given in thousand LOC (KLOC) and Effort is in person-month. Three models of COCOMO given by Barry Boehm Simple COCOMO: It was the first model suggested by Barry Boehm, which follows following formula: $Effort = a \cdot (KLOC)^b$ where S is the code-size, and a, b are complexity factors. This model uses three sets of a, b depending on the complexity of the software only as given in table IX. The basic COCOMO model is simple and easy to use. As many cost factors are not considered, it can only be used as a rough estimate.

Intermediate COCOMO: In the intermediate COCOMO, a nominal effort estimation is obtained using the power function with three sets of a, b, with coefficient a being slightly different from that of the basic COCOMO as shown in table 1.

Model	a	b
Organic (Simple in terms of size and complexity)	3.2	1.05
Semi-ditched (Average in terms of size and complexity)	3.0	1.15
Embedded (Complex)	2.8	1.20

Table 1: Depicting model and values for a and b

Expertise Based Estimation

It is the most frequently applied estimation strategy for software projects. There is no substantial evidence for use of estimation based models however there are situations where one can expect expert based estimation to be more precise than formal methods. This method is usually used when there is limitation in finding data and gathering

requirements. Consultation is the basic issue in this method. The following expert

AMSCCE - 1101

estimation best practice guidelines are considered aiming at reducing the size of situational and human biases in expert estimation.

- Evaluate estimation accuracy, but avoid high evaluation pressure.
- Avoid conflicting estimation goals.
- Ask the estimators to justify and criticize their estimates.
- Avoid irrelevant and unreliable estimation information.
- Use documented data from previous development tasks.
- Find estimation experts with relevant domain background and good estimation records.
- Estimate top-down and bottom-up, independently of each other.
 - Use estimation checklists.
- Combine estimates from different experts and estimation strategies.
- Assess the uncertainty of the estimate.

Delphi Method:

The aim of Delphi method is to combine expert opinion and prevent bias due to positions, status or dominant personalities. Delphi arranges an especial meeting among the project experts and tries to achieve the true information. Delphi includes some steps as,

- a) The coordinator gives an estimation form to each expert.
- b) Each expert presents his own estimation (without discussing with others).
- c) The coordinator gathers all Forms and sum them up and start another iteration.
- d) steps (b-c) are repeated until an approval is gained.

Rule Based Systems: Uses human expert knowledge to solve real-world problems that normally would require human intelligence. Expert knowledge is often represented in the form of rules or as data within the Personnel Capability = Low THEN Risk Level = High

Bayesian Belief Network

It is the process of forecasting the software effort to estimate software costs of both development and maintenance. In the past decades, various kinds of software cost and effort estimation methods have been proposed. However, there is no optimal approach to accurately predict the effort needed for developing a software system. Because, the information gathered at the early stages of software system development is insufficient for providing a precise effort prediction. It is a complex activity that requires knowledge of a number of key attributes. Bundle of data is needed, which is often impossible to get in needed quantities. Hence, Bayesian Belief Networks are effective for cost and effort estimation [9], [14]. BBNs are especially useful when the information about the past and/or the current situation is vague, incomplete, conflicting, and uncertain. They are a very effective method of modeling uncertain situations that depend on cause and effect. They are compact networks of probabilities that capture the probabilistic relationship between variables, as well as historical information about their relationships. BBNs are very effective for modeling situations where some information is already known and incoming data is uncertain or partially unavailable. An important fact to realize about Bayesian Belief Networks is that they are not

dependent on knowing exact historical information or current evidence.

AMSCCE - 1101

9	<p>Discuss in detail about COSMIC full function points. (Apr 19)</p> <p>Function Point Analysis (FPA) is one of the most widely used methods to determine the size of software projects. FPA originated at a time when only a mainframe environment was available. Sizing of specifications was typically based on functional decomposition and modeled data. Nowadays, development methods like Object Oriented, Component Based and RAD are applied more often. There is also more attention on architecture and the use of client server and multitier environments. Another development is the growth in complexity caused by more integrated applications, real-time applications and embedded systems and combinations. FPA was not designed to cope with these various newer development approaches.</p> <p>The Common Software Measurement International Consortium (COSMIC), aimed to develop, test, bring to market and to seek acceptance of a new software sizing method to support estimating and performance measurement (productivity, time to market and quality). The measurement method must be applicable for estimating the effort for developing and maintaining software in various software domains. Not only business software (MIS) but also real time software (avionics, telecom, process control) and embedded software (mobile phones, consumer electronics) can be measured.</p> <p>The basis for measurement must be found, just as in FPA, in the user requirements the software must fulfill. The result of the measurement must be independent of the development environment and the method used to specify these requirements. Sizes depend only on the user require.</p> <p>COSMIC Concepts</p> <p>The Functional User Requirements (FUR) are, according to the definition of a functional size measurement method, the basis for measurement. They specify user's needs and procedures that the software should fulfill.</p> <p>The FUR are analyzed to identify the functional processes. A Functional Process is an elementary component of a set of FUR. It is triggered by one or more events in the world of the user of the software being measured. The process is complete when it has executed all that is required to be done in response to the triggering event.</p> <p>Each functional process consists of a set of sub processes that are either movements or manipulations of data. Since no one knows how to measure data manipulation, and since the aim is to measure 'data movement rich' software, the simplifying assumption is made that each functional process consists of a set of data movements.</p> <p>A Data Movement moves one Data Group. A Data Group is a unique cohesive set of data (attributes) specifying an 'object of interest' (i.e. something that is 'of interest' to the user). Each Data Movement is counted as one CFP (COSMIC function point).</p> <p>COSMIC recognizes 4 (types of) Data Movements:</p> <ul style="list-style-type: none">❖ Entry moves data from outside into the process❖ Exit moves data from the process to the outside world❖ Read moves data from persistent storage to the process❖ Write moves data from the process to persistent storage.
---	---

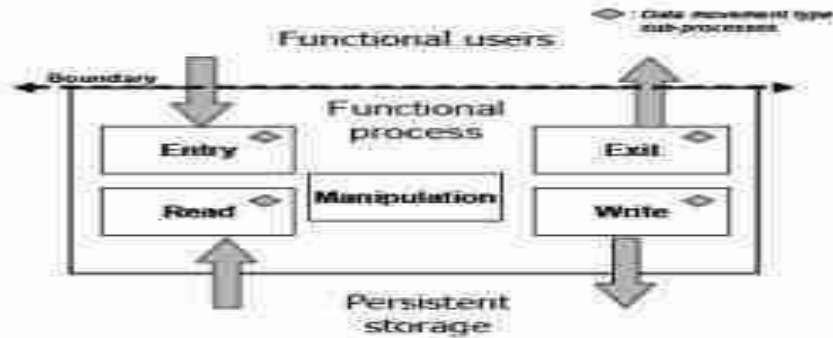

From a pure size measurement point of view, the most important improvements of the COSMIC method compared with using traditional Function Points are as follows

- ❖ The COSMIC method was designed to measure the functional requirements of software in the domains of business application, real-time and infrastructure software (e.g. operating systems, web components, etc.), in any layer of a multi-layer architecture and at any level of decomposition. Traditional Function Points were designed to measure only the functionality 'seen' by human users of business software in the application layer.
- ❖ Traditional Function Points use a size scale with a limited range of possible sizes for each component. COSMIC functional processes are measured on a continuous size scale with a minimum of 2 CFP and no upper size limit. Modern software can have extremely large processes. Individual functional processes of roughly 100 CFP have been measured in avionics software systems and in public national insurance systems. Traditional Function Points can therefore give highly misleading sizes for certain types of software which means that great care must be taken when using these sizes for performance measurement or estimating
- ❖ The COSMIC method gives a much finer measure of the size of any changes to be made to software than traditional function points. The smallest change that can be measured with the COSMIC method is 1 CFP.

Users of the COSMIC method have reported the following benefits, compared with using '1st generation' methods

- ❖ Easy to learn and stable due to the principles-based approach, hence 'future proof' and cost-effective to implement;
- ❖ Well-accepted by project staff due to the ease of mapping of the method's concepts to modern software requirements documentation methods, and to its compatibility with modern software architectures;
- ❖ Improves estimating accuracy, especially for larger software projects;
- ❖ Possible to size requirements automatically that are held in CASE tools;
- ❖ Reveals real performance improvement where using traditional function points has not indicated any improvement due to their inability to recognize how software processes have increased in size over time;
- ❖ Sizing with COSMIC is an excellent way of controlling the quality of the

requirements at all stages as they evolve.

AMSCE - 1101

10 Explain in about COCOMO II a parametric productivity model. (Nov/Dec 18,19)

COCOMO a parametric model

COCOMO (Constructive Cost Estimation Model) was proposed by Boehm. According to him, any software development project can be classified into one of the following three categories based on the development complexity: organic, semidetached, and embedded. The classification is done considering the characteristics of the product as well as those of the development team and development environment. Usually these three product classes correspond to application, utility and system programs, respectively. Data processing programs are normally considered to be application programs. Compilers, linkers, etc., are utility programs. Operating systems and real-time system programs, etc. are system programs.

The definition of organic, semidetached, and embedded systems are elaborated below.

- Organic: A development project can be considered of organic type, if the project deals with developing a well understood application program, the size of the development team is reasonably small, and the team members are experienced in developing similar types of projects.
- Semidetached: A development project can be considered of semidetached type, if the development consists of a mixture of experienced and inexperienced staff. Team members may have limited experience on related systems but may be unfamiliar with some aspects of the system being developed.
- Embedded: A development project is considered to be of embedded type, if the software being developed is strongly coupled to complex hardware, or if the stringent regulations on the operational procedures exist.

According to Boehm, software cost estimation should be done through three stages: Basic COCOMO, Intermediate COCOMO, and Complete COCOMO.

Basic COCOMO Model

The basic COCOMO model gives an approximate estimate of the project parameters. The basic COCOMO estimation model is given by the following expressions:

$$\text{Effort} = a * (\text{KLOC})^b \text{ PM } \text{Tdev} = 2.5 * (\text{Effort})^c \text{ Months}$$

where

- KLOC is the estimated size of the software product expressed in Kilo Lines of Code a, b, c are constants for each category of software products
- Tdev is the estimated time to develop the software, expressed in months
- Effort is the total effort required to develop the software product, expressed in person months (PMs)

The effort estimation is expressed in units of person-months (PM). The value of the constants a, b, c are given below:

Software project	a	b	c
Organic	2.4	1.05	0.38
Semi-detached	3.0	1.12	0.35

		Embedded	3.6	1.20	0.32	
--	--	----------	-----	------	------	--

AMSCCE - 1101

Intermediate COCOMO Model

The basic COCOMO model assumes that effort and development time are functions of the product size alone. However, many other project parameters apart from the product size affect the development effort and time required for the product. Therefore, in order to obtain an accurate estimation of the effort and project duration, the effect of all relevant parameters must be taken into account.

The intermediate COCOMO model recognizes this fact and refines the initial estimate obtained using the basic COCOMO expressions by using a set of 15 cost drivers (multipliers) based on various attributes of software development. For example, if modern programming practices are used, the initial estimates are scaled downward by multiplication with a cost driver having a value less than 1.

Each of the 15 attributes receives a rating on a six-point scale that ranges from "very low" to "extra high" (in importance or value) as shown below. An effort multiplier from the table below [i] applies to the rating. The product of all effort multipliers results in an Effort Adjustment Factor (EAF).

Cost Drivers	Ratings					
	Very Low	Low	Nominal	High	Very High	Extra High
Product attributes						
Required software reliability	0.75	0.88	1.00	1.15	1.40	
Size of application database		0.94	1.00	1.08	1.16	
Complexity of the product	0.70	0.85	1.00	1.15	1.30	1.65
Hardware attributes						
Run-time performance constraints			1.00	1.11	1.30	1.66
Memory constraints			1.00	1.06	1.21	1.56
Volatility of the virtual machine environment		0.87	1.00	1.15	1.30	
Required turnabout time		0.87	1.00	1.07	1.15	
Personnel attributes						
Analyst capability	1.46	1.19	1.00	0.86	0.71	
Applications experience	1.29	1.13	1.00	0.91	0.82	
Software engineer capability	1.42	1.17	1.00	0.86	0.70	
Virtual machine experience	1.21	1.10	1.00	0.90		
Programming language experience	1.14	1.07	1.00	0.95		
Project attributes						
Application of software engineering methods	1.24	1.10	1.00	0.91	0.82	
Use of software tools	1.24	1.10	1.00	0.91	0.83	
Required development schedule	1.23	1.08	1.00	1.04	1.10	

EAF is used to refine the estimates obtained by basic COCOMO as follows:

$$\text{Effort | corrected} = \text{Effort} * \text{EAF}$$

$$\text{Tdev | corrected} = 2.5 * (\text{Effort | corrected})^c$$

Complete COCOMO Model

Both the basic and intermediate COCOMO models consider a software product as a single homogeneous entity. However, most large systems are made up several smaller sub-systems, each of them in turn could be of organic type, some semidetached, or embedded. The complete COCOMO model takes into account these differences in characteristics of the subsystems and estimates the effort and development time as the sum of the estimates for the individual subsystems. This approach reduces the percentage of error in the final estimate.

The following development project can be considered as an example application of the complete COCOMO model. A distributed Management Information System (MIS) product for an organization having offices at several places across the country can have the following sub-components:

- Database part
- Graphical User Interface (GUI) part
- Communication part

Of these, the communication part can be considered as embedded software. The database part could be semi-detached software, and the GUI part organic software. The costs for these three components can be estimated separately, and summed up to give the overall cost of the system.

11 Write short notes on Staffing Pattern. (Apr 18)

Resource allocation in software development is important and many methods have been proposed. Related empirical research is yet scarce and evidence is required to validate the theoretical methods. This paper introduces the staffing pattern as a metric of resource distribution among project phases, and verifies its effect on software quality and productivity using real project data. The main findings are: (1) there exist different staffing patterns in reality; (2) the staffing pattern has significant effect on software quality (post-release defect density); (3) the staffing pattern has no significant effect on productivity; (4) the effort invested on test, document or code inspection possibly explains the effect of staffing pattern on software quality; (5) the effort consumed by rework perhaps counteracts the effect of other potential factors on productivity. Preliminary heuristics are suggested to resource allocation practices.

We name these as staffing patterns as follows:

(1) Rapid-team-buildup pattern (abbreviated Rapid for later reference). The staffing levels peak in requirement phase, and decrease in later phases. This might mean the culture of excessive documentation or design, leading to low ability to respond rapidly for requirement change. Another possible reason would be to outsource part of the system to other organization for design and development. In both situations, we suppose the software quality and productivity are low.

(2) Fix-staff pattern (abbreviated Fix). The team size is fixed or stable across project lifecycle. It is likely that the same team has done all work. Due to sufficient learning time and communication within the team, we assumed that high software quality will be yielded as a result. It is hard to assess its productivity: perhaps peoples work efficiently due to effective communication, perhaps this effect cannot counteract against the excessive human resources investment in a prolonged duration.

(3) Design-construction-centric pattern (abbreviated Design). The staffing levels are high in design and construction phases, and low in other phases. The reason for low staffing level in requirement and test phases may be indifference to them, or mature/simple product. The software quality and productivity might be low for the former possibility, and high for the latter.

(4) Implementation-centric pattern (abbreviated Implement). The staffing levels are high in construction and test phases, and low in other phases. The reason for low staffing level in requirement and design phases may be indifference to them, or merely providing coding and testing services in IT outsourcing market. The software quality and productivity would be low for the former possibility, and high for the latter.

(5) Test-centric pattern (abbreviated Test). The staffing levels are relatively low in early phases, but increase in test and transition phases. The increasing level in test phase may be the result of intensive testing by a special team (in-house or outsourcing), or fire-fighting for too many bugs. The software quality may be high, because the staffing level in early phases is also stable and the situation is the same as Fix-staff pattern. Moreover, it is possible that high staffing level in test or transition phase detects and removes more defects before delivery. Similar to Fix-staff pattern, its productivity is hard to be determined.

(6) Classical-Rayleigh pattern (abbreviated Rayleigh). Similar to classical Rayleigh curve, the staffing levels are low at the beginning, gradually increase, peak at construction phase, and drop at later phases. It is the most common pattern in our data set. We assumed that the productivity is high in this situation, but the yield may be low quality pertaining to insufficient communication inside team.

(7) Minimum-design pattern (abbreviated Mini Design). The trend of staffing level is an "M" shape with 2 peaks at requirement and construction or test phases. Possibly the design phase is minimized due to indifference to it, architecture reuse, mature or simple product. It is also possible that several senior developers are branched from the whole team (and the design is parallel with other phase) rather than a turnover of staff. The software quality and productivity might be low for the first possibility (indifference), hard to assess for the last (branching), and high for the other possibilities.

UNIT III ACTIVITY PLANNING AND RISK MANAGEMENT

Objectives of Activity planning - Project schedules - Activities - Sequencing and scheduling - Network Planning models - Forward Pass & Backward Pass techniques - Critical path (CRM) method - Risk identification - Assessment - Monitoring - PERT technique - Monte Carlo simulation - Resource Allocation - Creation of critical patterns - Cost schedules.

PART-A

1	<p>What are the objectives of activity planning? (Dec 12,19,May 13, Apr 19)</p> <ul style="list-style-type: none">✓ Feasibility assessment✓ Resource allocation✓ Detailed costing✓ Motivation✓ Co-ordination
---	---

AMSCCE - 1101

2	<p>Define Project Schedule.</p> <p>A stage of a larger project, the project plan must be developed to the level of showing dates when each activity should start and finish and when and how much of each resource will be required. Once the plan has been refined to this level of detail we call it a project schedule.</p>
3	<p>What are the three approaches to identify the activities that make up a project?</p> <p>Essentially there are three approaches to identifying the activities or tasks that make up a project</p> <ul style="list-style-type: none"> ✓ The activity-based approach, ✓ The product-based approach ✓ The hybrid approach.
4	<p>Define activities</p> <ul style="list-style-type: none"> ✓ If an activity must have a clearly defined start and a clearly defined end-point, normally marked by the production of a tangible deliverable. ✓ An activity requires a resource (as most do) then that resource requirement must be forecast able and is assumed to be required at a constant level throughout the duration of the activity. ✓ The duration of an activity must be forecast able – assuming normal circumstances, and the reasonable availability of resources. ✓ Some activities might require that others are completed before they can begin these are known as precedence requirements).
5	<p>What do you understand by work breakdown structure (WBS)? (Dec 14)</p> <p>This involves identifying the main (or high level) tasks required to complete a project and then breaking each of these down into set of lower-level tasks.</p> <p>Five levels of WBS.</p> <ul style="list-style-type: none"> ✓ Project- engineering resources has been developed by TASK ✓ Deliverables- term for the quantifiable goods or services ✓ Components- designing the floor plane ✓ work-packages- Models for the description of software artifacts ✓ Tasks- Creation and distribution of organizing software
6	<p>What are the rules for constructing precedence networks?</p> <ul style="list-style-type: none"> ✓ A project network should have only one start node. ✓ A project network should have only one end node. ✓ A node has duration. ✓ Links normally have no duration. ✓ Precedents are the immediate preceding activities. ✓ Times moves from left to right ✓ A network may not contain loops. ✓ A network should not contain dangles.

7	Define Hammock activities. (Dec 13) Hammock activities which, in themselves, have zero duration but are assumed to start at the same time as the first 'ham mocked' activity and to end at the same time as the last one.
---	---

AMSCCE - 1101

8	<p>What is meant by forward pass? (Nov/Dec 2018)</p> <p>The forward pass is carried out to calculate the earliest dates on which each activity may be started and completed. Significance-calculation method used in Critical Path Method.</p>
9	<p>What is meant by backward pass? (Nov/Dec 2018)</p> <p>The second stage in the analysis of a critical path network is to carry out a backward pass to calculate the latest date at which each activity may be started and finished without delaying the end date of the project. The calculating the latest dates, we assume that the latest finish date for the project is the same as the earliest finish date—that is we wish to complete the project as early as possible.</p>
10	<p>What is critical path?</p> <p>There will be at least one path through the network that defines the duration of the project. This is known as critical path. Any delay to any activity on this critical path will delay the completion of the project.</p>
11	<p>What do you mean by activity-based approach?</p> <p>The activity based approach consists of creating a list of all the activities that the project is thought to evolve.</p>
12	<p>What are the measures of activity float?</p> <p>Free float: the time by which an activity may be delayed without affecting any subsequent activity</p> <p>Interfering float: the difference between total float and free float. This is quite commonly used, particularly in association with the free float.</p>
13	<p>Define activity float.</p> <p>The difference between an activity's earliest start date and its latest start date (or difference between an activity's earliest and latest finish dates) is known as the activity's float—it is measure of how much the start or completion of an activity may be delayed without affecting the end date of the project. Any activity with a float of zero is critical (any delay in carrying out the activity delay the completion date of the project as a whole).</p>
14	<p>What is the significance of a critical path? (Dec 14)</p> <ul style="list-style-type: none"> ✓ In managing the project, we must pay particular attention to monitoring activities on the critical path so that the effects of any delay or resource unavailability are detected and corrected at the earliest opportunities. ✓ In planning the project, it is the critical path that we must shorten if we are to reduce the overall duration of the project.
15	<p>Write any three network diagram methods?</p> <ul style="list-style-type: none"> ✓ PERT – Program evaluation and review technique. ✓ CPM – Critical path method. ✓ ADM – Arrow Diagramming method.

16	Define Risk Identification. (Apr 19) Risk management begins with analyzing the risks involved in the project. Risk identification is not a one-off initiative since projects are constantly evolving and new risks arise while other risks may dissipate or reduce in importance.
----	---

AMSCCE - 1101

17	<p>What is meant by known Risk?</p> <p>Risk is defined “an uncertain event or condition that, if it occurs has a positive or negative effect on a project objectives”. It includes transferring the risk to another party, avoiding the risk, reducing the negative effect of the risk, and accepting some or all of the consequences of a particular risk.</p>
18	<p>What is risk management? (Dec 11)</p> <p>Risk management process begins when somebody asks what kind of events can damage the business and how much damage can be done. Identifying and measuring the potential loss exposures, choosing the most efficient methods of controlling and financing loss exposure and implementing them and finally monitoring all the outcomes are the main steps involved in Risk Management.</p>
19	<p>List out the framework for dealing with risk</p> <ul style="list-style-type: none"> ✓ Risk identification - what risks might there be? ✓ Risk analysis and prioritization - which are the most serious risks? ✓ Risk planning - what are we going to do about them? ✓ Risk monitoring - what is the current state of the risk?
20	<p>List the factors used to identify the risk. (Dec 12)</p> <p>Approaches to identifying risks include:</p> <ul style="list-style-type: none"> ✓ Use of checklists - usually based on the experience of past projects. ✓ Brainstorming - getting knowledgeable stakeholders together to pool concerns. ✓ Causal mapping - identifying possible chains of cause and effect.
21	<p>Draw the categories of risk.</p>  <pre> graph TD S[Structure] --> A[Actors] A --> T[Technology] T --> Tasks[Tasks] Tasks --> S A <--> Tasks </pre>
22	<p>Define Risk Assessment.</p> <p>A systematic process of evaluating the potential risks that may be involved in a projected activity or undertaking.</p>
23	<p>What is PERT?</p> <p>Project Evaluation and Review Technique (PERT) is a project management tool used to schedule, organize, and coordinate tasks within a project. It estimation considers three values: the most optimistic estimate (O), a most likely estimate (M), and a pessimistic estimate (least likely estimate (L)).</p>

24	List the advantages of PERT Technique(Dec 19) <ul style="list-style-type: none">✓ Useful at many stages of project management✓ Mathematically simple✓ Give critical path and slack time✓ Provide project documentation✓ Useful in monitoring costs
----	---

AMSCCE - 1101

25	Difference between PERT and CPM.	
	PERT	CPM
	It is probabilistic whereas CPM is Deterministic.	It estimates of activity duration are based on historical data.
	It estimates are uncertain and we talk of ranges of duration and the probability that activity duration will fall into that range.	CPM concentrates on time/cost trade off.
26	<p>What is Monte Carlo (MC) method? (Apr 18, Dec 18) The Monte Carlo method is a numerical method for statistical simulation which utilizes sequences of random numbers to perform the simulation</p> <div style="text-align: center;">  <pre> graph LR A[Decision and uncontrollable variables] --> B[Simulation model] B --> C[Measures of performance or behaviour of the system] </pre> </div>	
27	<p>List out the components of Monte Carlo Simulation.</p> <ul style="list-style-type: none"> ✓ Probability Distribution Function. ✓ Random Number Generation. ✓ Sampling Rule. ✓ Scoring/Tallying. ✓ Error Estimation. ✓ Parallelization. 	
28.	<p>What is resource allocation? Resource Allocation is used to assign the variable resource in an economic way. In project management, resource allocation is the scheduling of activities and the resources required by those activities while taking into consideration both the resource availability and the project time.</p>	
29	<p>What are the categories of resources?</p> <ul style="list-style-type: none"> ✓ Labor ✓ Equipment (E.G. Workstations) ✓ Materials ✓ Space ✓ Services ✓ Time: Elapsed Time Can Often Be Reduced By Adding More Staff ✓ Money: Used To buy the other resources. 	
30	<p>List out Burman's priority list</p> <ul style="list-style-type: none"> ✓ Shortest critical activities ✓ Other critical activities ✓ Shortest non-critical activities ✓ Non-critical activities with least float ✓ Non-critical activities 	

31	<p>List out the schedules under resource allocation.</p> <ul style="list-style-type: none">✓ Activity Schedule indicating start and completion dates for each activity✓ Resource Schedule indicating dates when resources needed + level of resources✓ Cost Schedule showing accumulative expenditure
----	--

AMSCCE - 1101

32	How costs are categorized? ✓ Staff costs ✓ Overheads ✓ Usage charges
33	Define staff costs. Staff costs includes not just salary, but also social security contributions by the employer, holiday pay etc. Timesheets are often used to record actual hours spent on each project by an individual. One issue can be how time when a staff member is allocated and available to the project, but is not actually working on the project, is dealt with.
34	Define Overheads costs. Overheads e.g. space rental, service charges etc. Some overheads might be directly attributable to the project, in other cases a percentage of departmental overheads may be allocated to project costs.
35	Define Usage charges. Usage charges are some charges can be on a 'pay as you go' basis e.g. telephone charges, postage, car mileage – at the planning stage an estimate of these may have to be made.
36 Define monitoring (Apr 18) Exercising control over a project and ensuring that targets are met is a matter of regular monitoring- finding out what is happening and comparison of actual achievement against the schedule and, where necessary, revision of plans and schedules to bring the project as far as possible back on target.	
PART-B	

1	<p>Explain in detail about the objectives of activity planning? (Dec 13, Apr 19)</p> <ul style="list-style-type: none">• Ensure Appropriate resources available when required• Avoid different competing for the same resources at the same time• Produce a detailed schedule showing which staffs carry out each activity.• Time cash flow forecast• Replan the project during its life to correct drift from the target• A detailed plan against which actual achievement may be measured. <p>Objectives of activity planning</p> <p>Feasibility assessment</p> <p>Is the project possible within required timescales and resource constraints? It is not until we have constructed a detailed plan that we can forecast a completion date with any reasonable knowledge of its achievability.</p> <p>Resource allocation</p> <p>What are the most effective ways of allocating resources to the project. When should the resources be available? The project plan allows us to investigate the relationship between timescales and resource availability</p> <p>Detailed costing</p> <p>How much will the project cost and when is that expenditure likely to take place? After producing an activity plan and allocating specific resources, we can obtain more detailed estimates of costs and their timing.</p> <p>Motivation</p> <p>Providing targets and being seen to monitor achievement against targets is an effective way of motivating staff, particularly where they have been involved in setting those targets in the first place.</p> <p>Co-ordination</p> <p>When do the staff in different departments need to be available to work on a particular project and when do staff need to be transferred between projects? The project plan, particularly with large projects involving more than a single project team, provides an effective vehicle for communication and coordination among teams.</p>
---	--

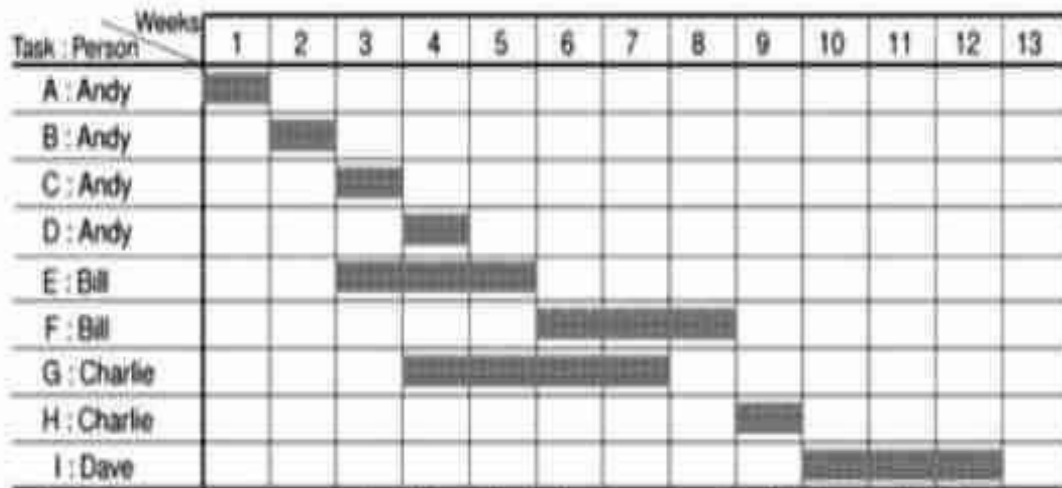

Activity key:

A: Overall design	F: Code module 3
B: Specify module 1	G: Code module 2
C: Specify module 2	H: Integration testing
D: Specify module 3	I: System testing
E: Code module 1	

2 Explain in detail about the steps involved in project schedule. (May 14, Apr 19)

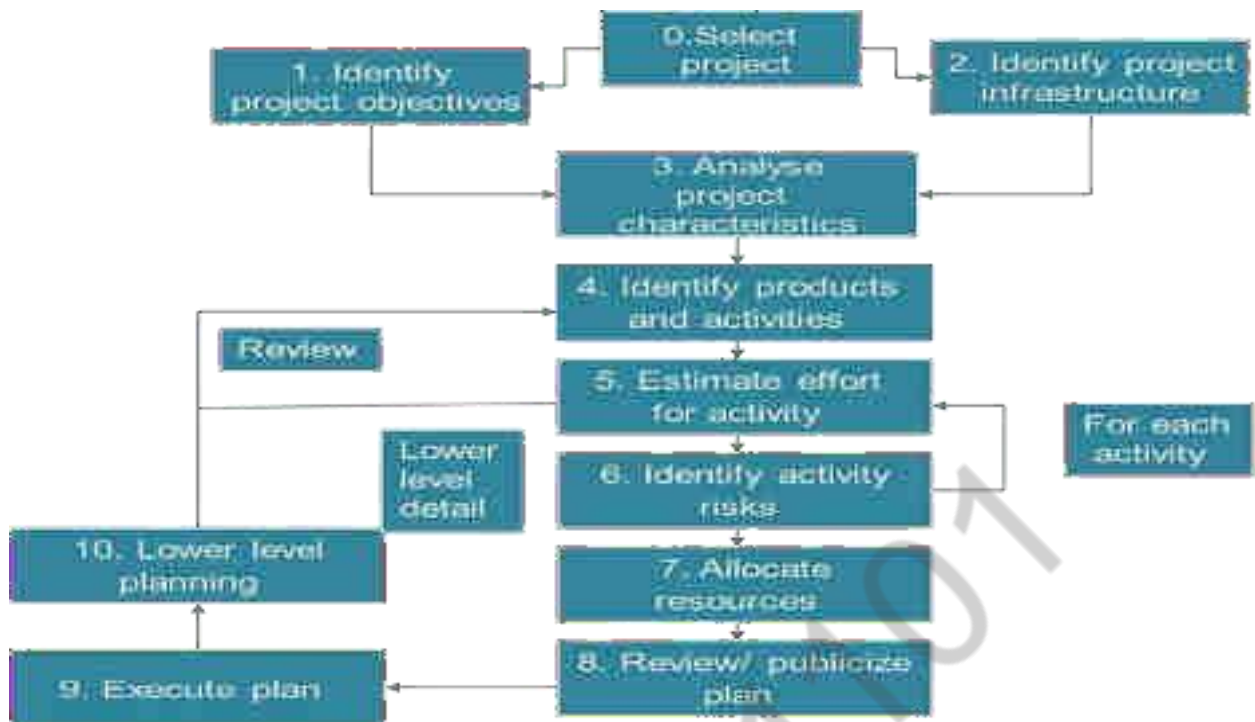

Step 1: Identify project scope and objectives.

Project objectives, Project authorities, and Modified project objectives.

Step 2: Identify project Infra structure.

Role of existing strategic plans, identifying standards, project organization.

Step 3: Analyze project characteristics, High-level risks.

Step 4: Identify project products and activities, Product break down structure, IOE has standard PFD, Identifying product instances, Activity network for IOE Maintenance Accounts.

Step 5: Estimate effort for each activity, IOE Maintenance Group Accounts- breaking

activities down into manageable tasks.

Step 6: Identify activity risks.

Identifying risks for Amanda

Step 7: Allocate Resources.

Taking resource constraints into account,

Step 8: Review/Publicize plan

IOE existing quality standards

Step 9 &10: Execute plan and lower levels of planning, lower level planning for individual modules.

AMSCCE - 1101

3 Explain the different network planning models. Give example for precedence construction. (Nov/Dec 2018,2019)

A project is made up of a sequence of activities that form a network representing a project.

- ❖ The path taking longest time through this network of activities is called the "critical path."
- ❖ The critical path provides a wide range of scheduling information useful in managing a project.
- ❖ Critical Path Method (CPM) helps to identify the critical path(s) in the project networks.
- ❖ CPM with a Single Time Estimate
 - ✓ Used when activity times are known with certainty.
 - ✓ Used to determine timing estimates for the project, each activity in the project, and slack time for activities.
- ❖ CPM with Three Activity Time Estimates (a.k.a. PERT)
 - ✓ Used when activity times are uncertain.
 - ✓ Used to obtain the same information as the Single Time Estimate model and probability information.

Time-Cost Models

- ❖ Used when trade-off information cost is a major consideration in planning.
- ❖ Used to determine the least cost in reducing total project time.

Example1:

CPM with Single Time Estimate Consider the following consulting project

Activity	Designation	Immed. Pred.	Time (Weeks)
Assess customer's needs	A	None	2
Write and submit proposal	B	A	1
Obtain approval	C	B	1
Develop service vision and goals	D	C	2
Train employees	E	C	5
Quality improvement pilot groups	F	D, E	5
Write assessment report	G	F	1

Develop a critical path diagram (network) and determine the duration of the critical path and Slack times for all activities

1. Draw the network
2. Compute early starts and early finish times (forward pass)
3. Compute late starts and late finish times (backward pass)
4. Compute Slack (LS-ES) per activity and Critical Path(s)

Example 2:

CPM with Three Activity Time Estimates Develop a critical path diagram (network) and determine the duration of the critical path and Slack times for all activities

1. Draw the network
2. Compute early starts and early finish times (forward pass)
3. Compute late starts and late finish times (backward pass)
4. Compute Slack (LS-ES) per activity and Critical Path(s)

What is the probability of finishing this project in less than 53 days?

What is the probability that the project duration will exceed 56 days?

Time-Cost Models

- ❖ Sometimes it is possible to "crash" (expedite) some activities thus reducing the overall completion time for the entire project.
- ❖ Crashing an activity implies spending additional funds (e.g., overtime costs, hiring more workers, and so on) to get the task done earlier

On many occasions reducing the project completion time that in turn reduces the fixed cost outlays can generate substantial savings.

1. Draw the CPM network, identify the CP
2. Identify the least cost activity(ies) on the critical path(s)
3. Shorten the project completion time (CP) at the least cost Repeat until no more crashing is possible (or cost exceeds the benefits)

- Assume fixed costs = \$1,000 day.
- Find the optimum time-cost schedule.

CPM Assumptions/Limitations

- ❖ Project activities can be identified as entities. (There is a clear beginning and ending point for each activity.)
- ❖ Project activity sequence relationships can be specified and networked.
- ❖ Project control should focus on the critical path.
- ❖ The activity times follow the beta distribution, with the variance of the project assumed to equal the sum of the variances along the critical path. Project control should focus on the critical path.

Project Evaluation and Review Technique (PERT)

PERT is a project management tool used to schedule, organize, and coordinate tasks within a project. It estimation considers three values: the most optimistic estimate (O), a most likely estimate (M), and a pessimistic estimate (least likely estimate (L)).

Evaluate the PERT techniques

Three estimates are produced for each activity

AMSCCE - 1101

- Most likely time (*m*)
- Optimistic time (*a*)
- Pessimistic (*b*)

$$\text{Expected time } t_e = (a + 4m + b) / 6$$

$$\text{Activity standard deviation } S = (b-a)/6$$

- Expected time: Helps to carry out a forward pass through a network similar to CPM
- Activity standard deviation: Used as ranking measure of the degree of uncertainty or risk for each activity.

Activity	Optimistic (a)	Most likely (m)	Pessimistic (b)	Expected te	Standard deviation s
A	5	6	8	6.17	0.5
B	3	4	5	4.00	0.33
C	2	3	3	2.83	0.17
D	3.5	4	5	4.08	0.25
E	1	3	4	2.83	0.5
F	8	10	15	10.50	1.17
G	2	3	4	3.00	0.33
H	2	2	2.5	2.08	0.08

Why Network Diagrams?

Splits up the decision making process into

- ❖ Method/logic - the order in which tasks have to be completed
- ❖ Time - estimates for the time to completion can be added to each task
- ❖ Resources - these can be added and then analysis carried out

Two Parts to the Analysis

- ❖ Forward Pass
 - ✓ Calculates the Duration of the Project
- ❖ Backward Pass
 - ✓ Calculates the slack/float for each task and shows the critical path

To calculate the total duration of the Project...

- ❖ For each task:
 - ✓ Take the earliest start time (EST)
 - ✓ Calculate the Earliest finish time (EFT):

$$EFT = EST + \text{Duration}$$

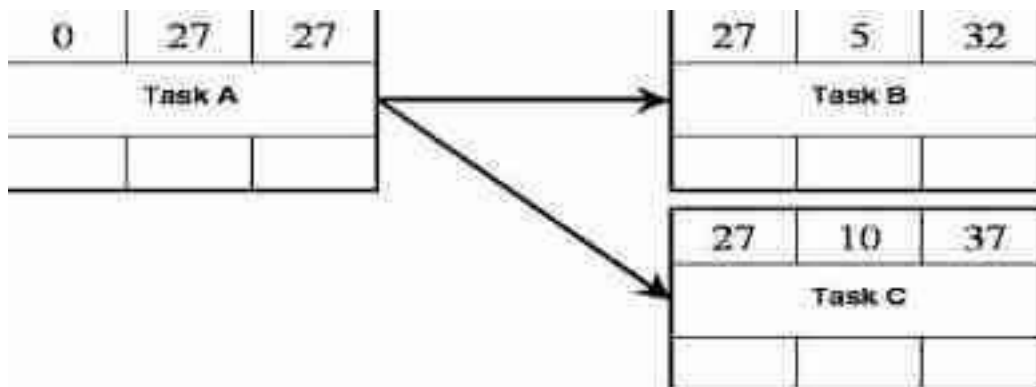

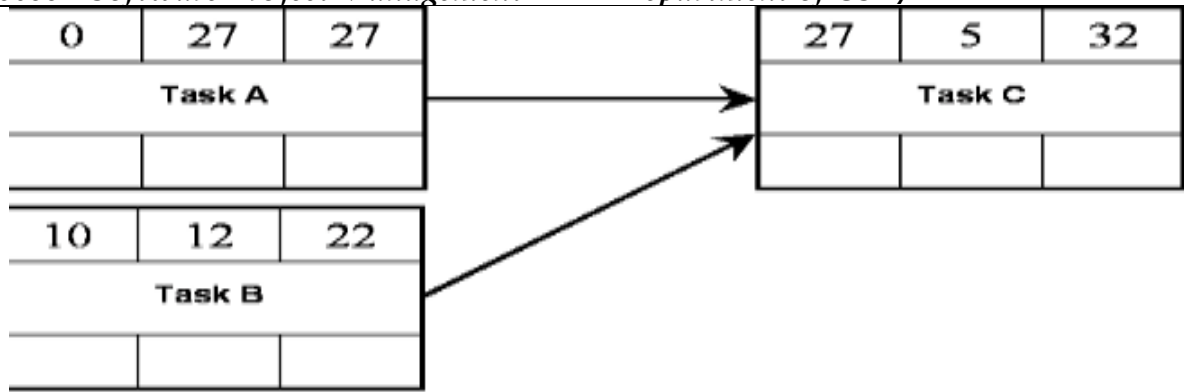

Backward Pass

- ❖ To calculate the float for each task?
- ❖ For each task:
 - ✓ Take the latest start time (LST)
 - ✓ Calculate the latest finish time (LFT):

$LST = LFT - \text{Duration}$

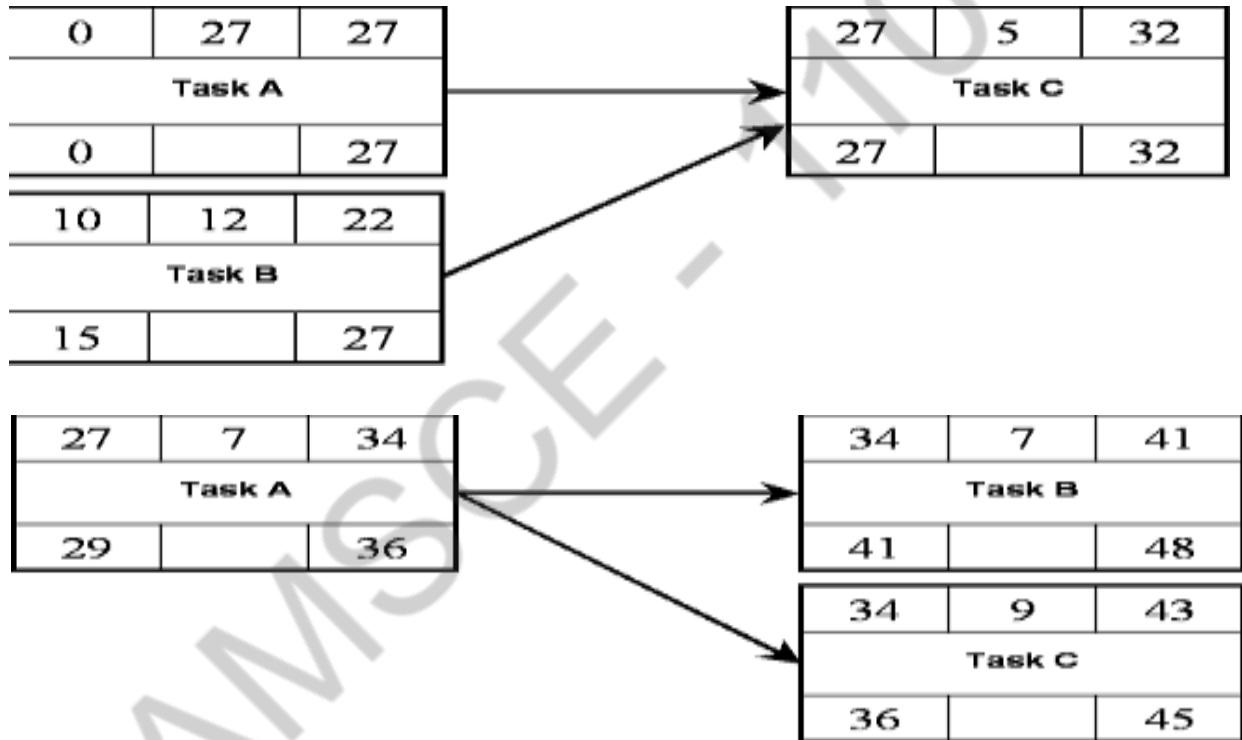

Constructing a Project Network

- ❖ Terminology
 - ✓ Activity: an element of the project that requires time.
 - ✓ Merge activity: an activity that has two or more preceding activities on which it depends.
 - ✓ Parallel (concurrent) activities: Activities that can occur independently and, if desired, not at the same time

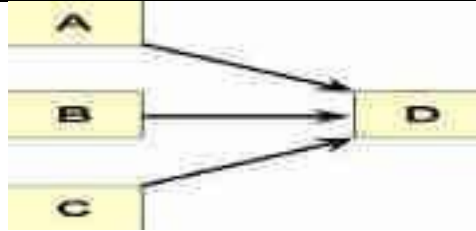

AMSCCE - 1101

Activity-on-Arrow Fundamentals



A is preceded by nothing
 B is preceded by A
 C is preceded by B

(A)

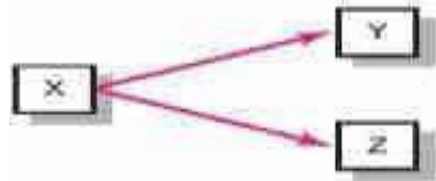

Y and Z are preceded by X

Y and Z can begin at the same time, if you wish

(B)

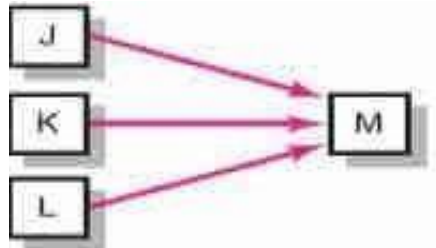

J, K, & L can all begin at the same time, if you wish (they need not occur simultaneously)

but

All (J, K, L) must be completed before M can begin

(C)

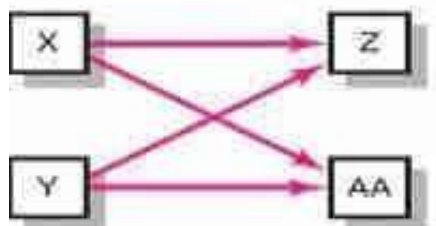

Z is preceded by X and Y

AA is preceded by X and Y

(D)

- ❖ Path: a sequence of connected, dependent activities.
- ❖ Critical path: the longest path through the activity network that allows for the completion of all project-related activities; the shortest expected time in which the entire project can be completed. Delays on the critical path will delay completion of the entire project.

Forward Pass Computation

- ❖ Add activity times along each path in the network ($ES + \text{Duration} = EF$).
- ❖ Carry the early finish (EF) to the next activity where it becomes its early start (ES) unless the next succeeding activity is a merge activity, in which case the largest EF of all preceding activities is selected.

Backward Pass Computation

- ❖ Subtract activity times along each path in the network ($LF - \text{Duration} = LS$).
- ❖ Carry the late start (LS) to the next activity where it becomes its late finish (LF) unless...
- ❖ The next succeeding activity is a burst activity, in which case the smallest LF of all preceding activities is selected.

Determining Slack (or Float)

- ❖ Free Slack (or Float)
 - The amount of time an activity can be delayed without delaying

connected successor activities

AMSCCE - 1101

❖ Total Slack

- The amount of time an activity can be delayed without delaying the entire project

❖ The critical path is the network path(s) that has (have) the least slack in common.

Sensitivity of a Network

- ❖ The likelihood the original critical path(s) will change once the project is initiated.

Function of:

The number of critical paths

The amount of slack across near critical activities

AMSCCE - 1101

4 Explain the importance of forward pass with an example. (Dec 14, May 15)

Forward pass

Table 6.2 The activity table after the forward pass

Activity	Duration (weeks)	Earliest start date	Latest Earliest Latest Total start date/finish date/float
A	6	0	6
B	4	0	4
C	3	6	9
D	4	4	8
E	3	4	7
F	10	0	10
G	3	10	13
H	2	9	11

The forward pass is carried out to calculate the earliest dates on which each activity may be started and completed.

The forward pass and the calculation of earliest start dates is calculated according to the following reasoning.

- Activities A, B and F may start immediately, so the earliest date for their start is zero.
- Activity A will take 6 weeks, so the earliest it can finish is week 6.
- Activity B will take 4 weeks, so the earliest it can finish is week 4.
- Activity F will take 10 weeks, so the earliest it can finish is week 10.
- Activity C can start as soon as A has finished so its earliest start date is week 6. It will take 3 weeks so the earliest it can finish is week 9.

- Activities D and E can start as soon as B is complete so the earliest they can each start is week 4. Activity D, which will take 4 weeks, can therefore finish by week 8 and activity E, which will take 3 weeks, can therefore finish by week 7.
- Activity G cannot start until both E and F have been completed. It cannot therefore start until week 10 – the later of weeks 7 (for activity E) and 10 (for activity F). It takes 3 weeks and finishes in week 13.
- Similarly, Activity H cannot start until week 9 – the later of the two earliest finished dates for the preceding activities C and a
- The project will be complete when both activities H and G have been completed. Thus the earliest project completion date will be the later of weeks 11 and 13 – that is, week 13.

The results of the forward pass are shown in Figure 6.18.

5 How to evaluate the pert techniques. (Dec 11, Apr 14, Apr 18)

Three estimates are produced for each activity

- ❖ Most likely time (m)
- ❖ Optimistic time (a)
- ❖ Pessimistic (b)

$$\text{Expected time } t_e = (a + 4m + b) / 6$$

$$\text{Activity standard deviation } S = (b-a)/6$$

- ❖ Expected time: Helps to carry out a forward pass through a network similar to CPM
- ❖ Activity standard deviation: Used as ranking measure of the degree of uncertainty or risk for each activity
- ❖ Pert labeling convention

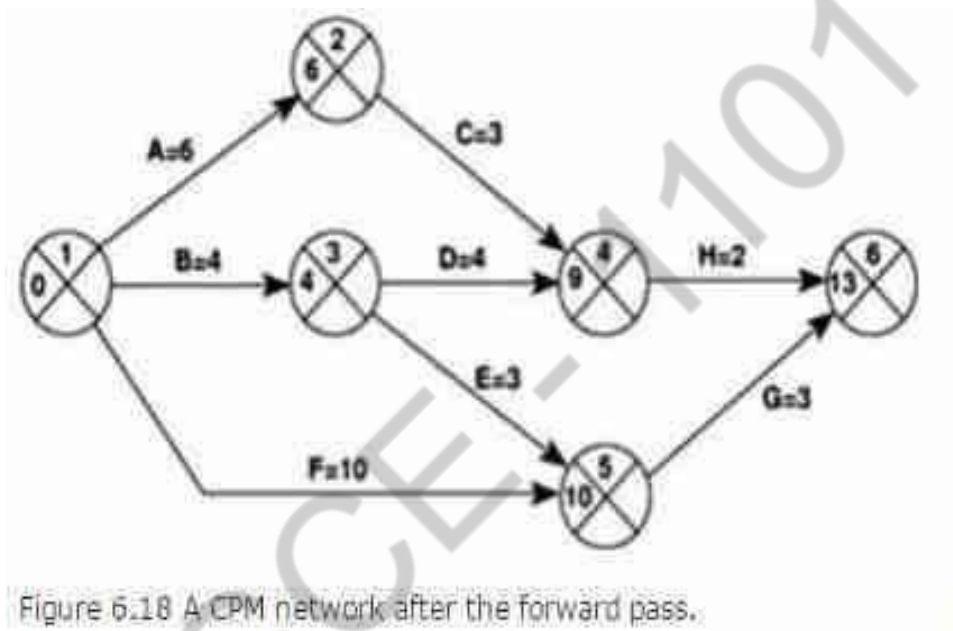

Event Number	Target Date
Expected Date	Standard deviation

Activity	Description	Precedents	Optimistic (a)	Most likely (m)	Pessimistic (b)
A	Hardware Selection		5	6	8
B	Software Design		3	4	5
C	Install Hardware	A	2	3	3
D	Code & test software	B	3.5	4	5
E	File take-on	B	1	3	4
F	Write user manuals		8	10	15
G	User training	E, F	2	3	4
H	Install and test	C,D	2	2	2.5

Activity	Optimistic (a)	Most likely (m)	Pessimistic (b)	Expected time	Standard deviations
A	5	6	8	6.17	0.5
B	3	4	5	4.00	0.33
C	2	3	3	2.83	0.17
D	3.5	4	5	4.08	0.25
E	1	3	4	2.83	0.5
F	8	10	15	10.50	1.17
G	2	3	4	3.00	0.33
H	2	2	2.5	2.08	0.08

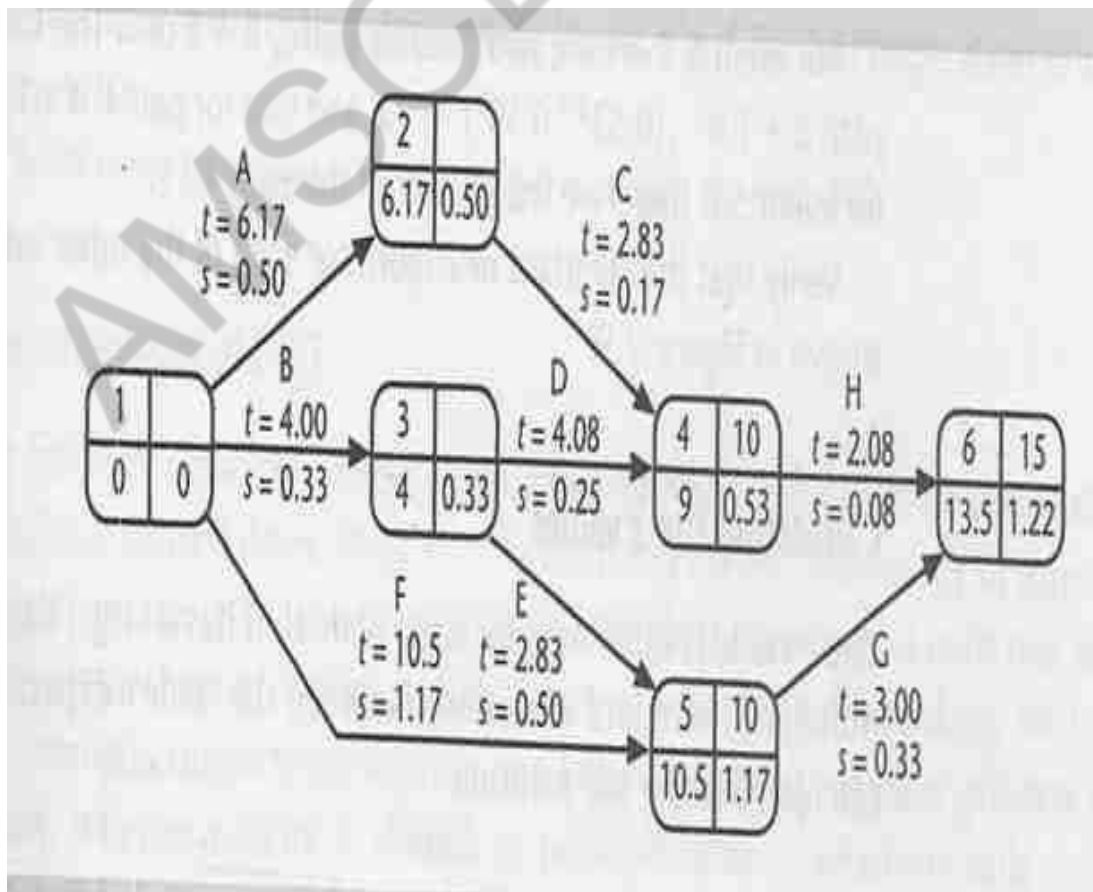

6	<p>Explain in detail about the risk identification. (Nov/Dec 2019)</p> <p>Risk identification</p> <p>Approaches to identifying risks include:</p> <ul style="list-style-type: none"> • Use of checklists - usually based on the experience of past projects • Brainstorming - getting knowledgeable stakeholders together to pool concerns • Causal mapping - identifying possible chains of cause and effect <p>Boehm's top 10 development risks</p>	
	<i>Risk</i>	<i>Risk reduction techniques</i>
	Personnel shortfalls	Staffing with top talent; job matching; teambuilding; training and career development; early scheduling of key personnel
	Unrealistic time and cost estimates	Multiple estimation techniques; design to cost; incremental development; recording and analysis of past projects; standardization of methods
	Developing the wrong software functions	Improved software evaluation; formal specification methods; user surveys; prototyping; early user manuals
	Developing the wrong user interface	Prototyping; task analysis; user involvement
	Gold plating	Requirements scrubbing, prototyping, design to cost
	Late changes to requirements	Change control, incremental development
	Shortfalls in externally supplied components	Benchmarking, inspections, formal specifications, contractual agreements, quality controls
	Shortfalls in externally performed tasks	Quality assurance procedures, competitive design etc
	Real time performance problems	Simulation, prototyping, tuning
	Development technically too difficult	Technical analysis, cost-benefit analysis, prototyping , training

7	<p>Explain in detail about the PERT technique and justify how PERT techniques provide details in identifying the uncertainties and effort in a project. Find out the expected duration and the standard deviation/ Create precedence for the following project. Calculate the earliest dates on which each activity may be started and completed of project using forward approach (Apr 18,19)</p> <p>Project Evaluation and Review Technique (PERT) is a project management tool used to schedule, organize, and coordinate tasks within a project. It estimation considers three values: the most optimistic estimate (O), a most likely estimate (M), and a pessimistic</p>
---	--

AMSCCE - 1101

	estimate (least likely estimate (L)).
--	---------------------------------------

AMSCCE - 1101

Evaluate the PERT techniques

Three estimates are produced for each activity

- Most likely time (*m*)
- Optimistic time (*a*)
- Pessimistic (*b*)

$$\text{Expected time } t_e = (a + 4m + b) / 6$$

$$\text{Activity standard deviation } S = (b-a)/6$$

- Expected time: Helps to carry out a forward pass through a network similar to CPM
- Activity standard deviation: Used as ranking measure of the degree of uncertainty or risk for each activity.
- Pert labeling convention

Event Number	Target Date
Expected Date	Standard deviation

Activity	Description	Precedents	Optimistic (a)	Most likely (m)	Pessimistic (b)
A	Hardware Selection		5	6	8
B	Software Design		3	4	5
C	Install Hardware	A	2	3	3
D	Code & test software	B	3.5	4	5
E	File take-on	B	1	3	4
F	Write user manuals		8	10	15
G	User training	E, F	2	3	4
H	Install and test	C,D	2	2	2.5

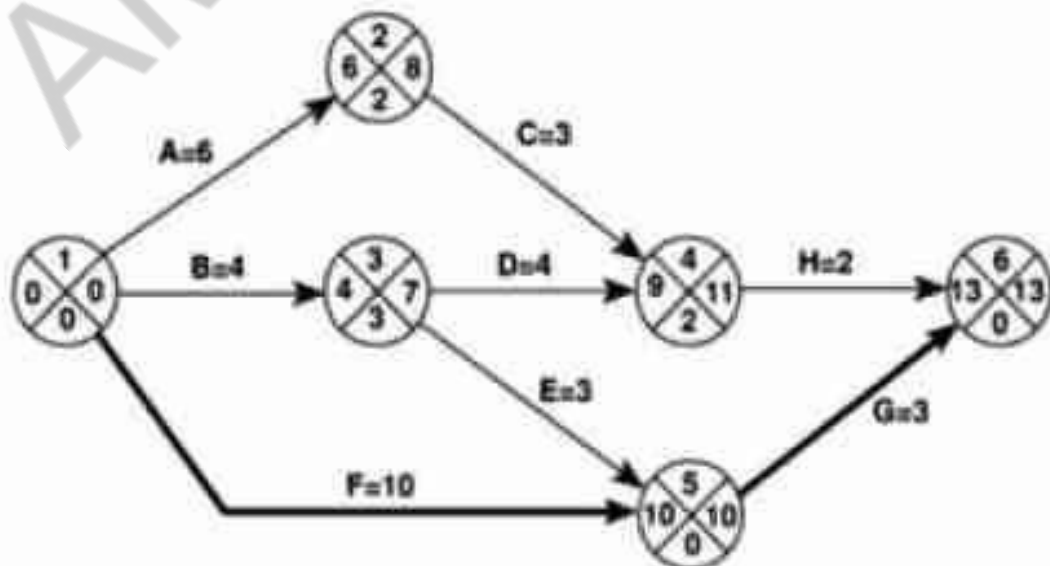

Fig 3 The critical path

PERT activity time estimates

Activity	Optimistic (a)	Activity durations(weeks), Most likely (m)	Pessimistic (b)
A	5	6	8
B	3	4	5
C	2	3	3
D	3.5	4	5
E	1	3	4
F	8	10	15
G	2	3	4
H	2	2	2.5

The above table provides additional activity duration estimates for the network shown in figure 3. There

Activity	Optimistic (a)	Most likely (m)	Pessimistic (b)	Expected te	Standard deviation s
A	5	6	8	6.17	0.5
B	3	4	5	4.00	0.33
C	2	3	3	2.83	0.17
D	3.5	4	5	4.08	0.25
E	1	3	4	2.83	0.5
F	8	10	15	10.50	1.17
G	2	3	4	3.00	0.33
H	2	2	2.5	2.08	0.08

Activity Standard Deviations

A quantitative measure of the degree of uncertainty of an activity duration estimate may be obtained by calculating the standard deviation of an activity time, using the formula $s = (b-a)/6$. The activity standard deviation is proportional to the difference between the optimistic and pessimistic estimates, and can be used as a ranking measure of the degree of uncertainty or risk for each activity.

The PERT technique uses the following three-step method for calculating the probability of meeting or missing a target date:

- Calculate the standard deviation of each project event;
- Calculate the z value for each that has a target date;

- Convert z values to a probabilities.

AMSCCE - 1101

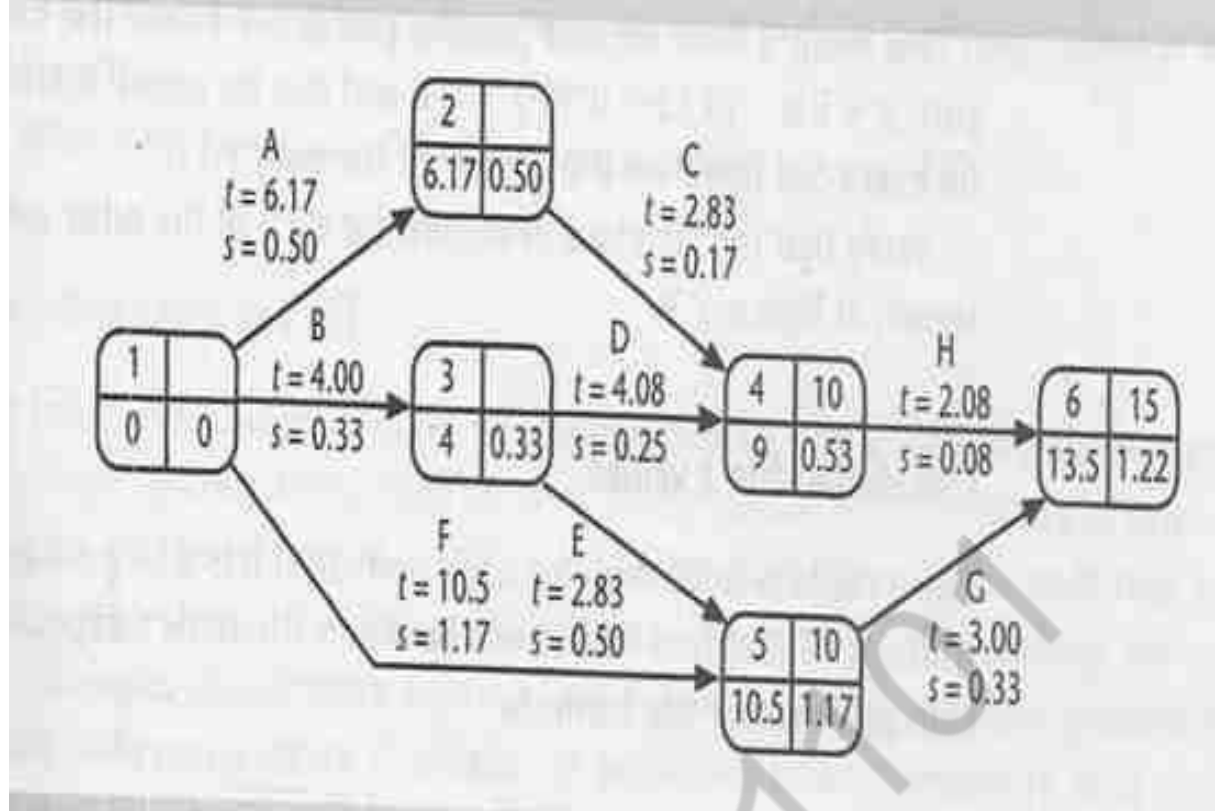

8 Explain with an example how critical path can be identified in precedence networks?
(Dec 11,19,Jun 13,Apr 18)

- Formulating a network model
- Constructing Precedence network
- Representing lagged activities
- Hammock activities
- Labeling conventions
- Adding the time dimension
 - Forward pass
 - Backward pass

A project usually consists of multiple activities that occur both simultaneously and sequentially. To determine the flow of these activities, you'll need to create a Precedence Diagram. After creating the Precedence Diagram, you can identify the activities that would, if delayed, cause your project to come in late. This is the Critical Path definition. A delay in any of the critical path activities will delay the entire project, regardless of whether the other project activities are completed on or before time. The act of determining the Critical Path is known as the Critical Path Method or the Critical Path Analysis.

To determine the Critical Path and conduct Critical Path Analysis, you need to:

- Define the duration of each activity.
- Identify all the paths.
- Calculate the duration of each path.
- Identify the longest path.
- Identifying the critical path

There will be at least one path through the network that defines the duration of the

project. This is known as critical path. Any delay to any activity on this critical path will delay the completion of the project.

Significance of critical path

- ❖ In managing the project, we must pay particular attention to monitoring activities on the critical path so that the effects of any delay or resource unavailability are detected at the earliest opportunities.
- ❖ In planning the project, it is the critical path that we must shorten if we are to reduce the overall duration of the project.

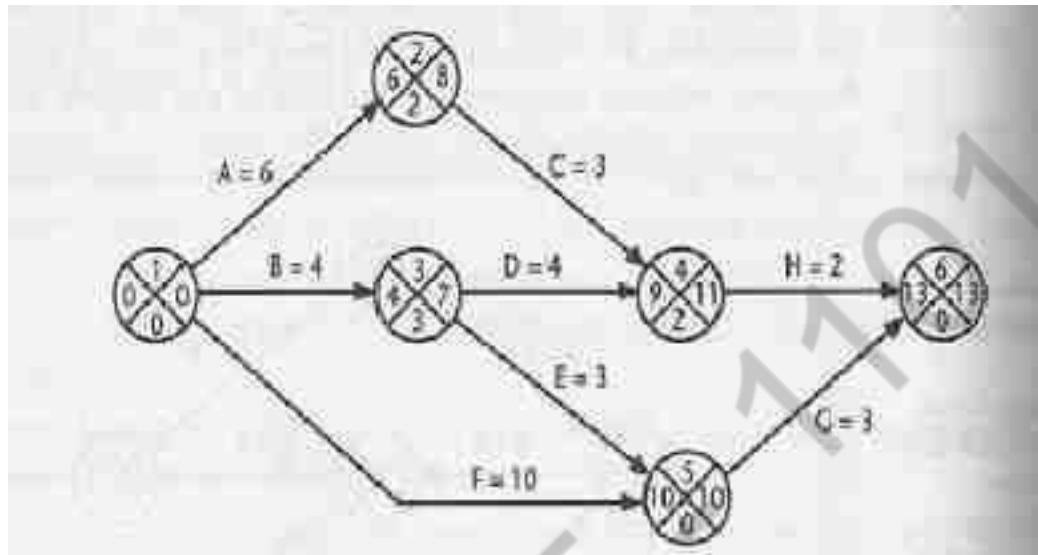

9 Explain in detail formulating a network model. (Dec 12, May 12)

Formulating a network model

The first stage in creating a network model is to represent the activities and their relationships as a graph. In activity-on-node we do this by representing **activities as nodes** in the graph-**the lines** between nodes represent **dependencies**.

Constructing precedence networks

- A project network should have only one start node.
- A project network should have only one end node.
- A node has duration.
- Links normally have no duration.
- Precedents are the immediate preceding activities. (Fig 6.9)

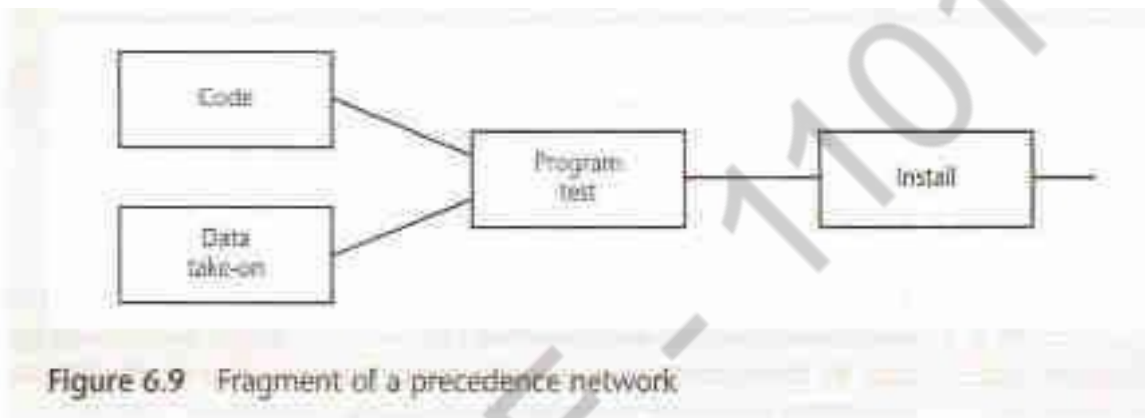

Figure 6.9 Fragment of a precedence network

- Times moves from left to right
- A network may not contain loops.(Fig 6.10)

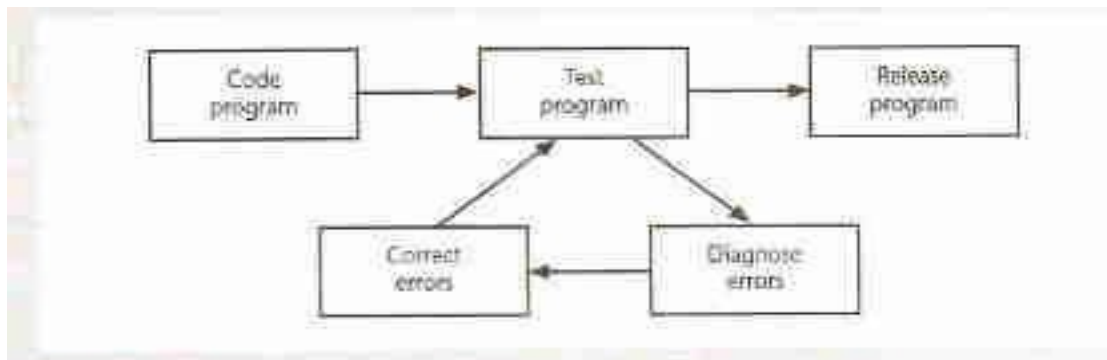

Figure 6.10: A loop represents an impossible sequence

- A network should not contain dangles.(Fig 6.11)

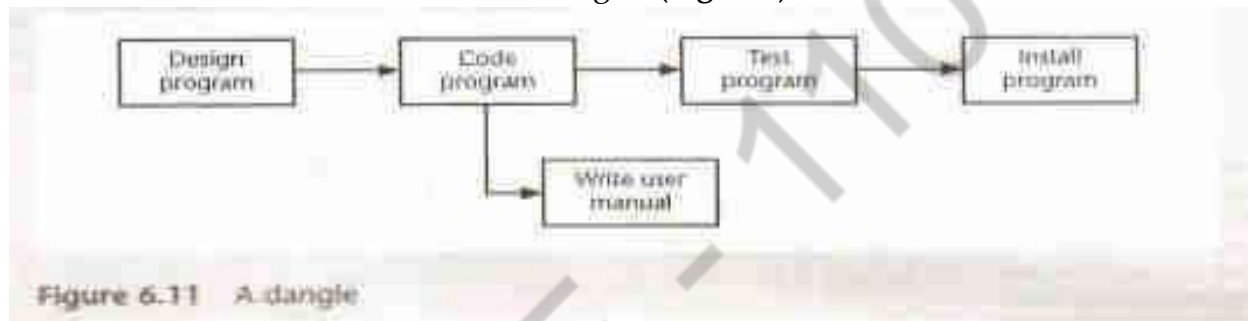

Figure 6.11: A dangle

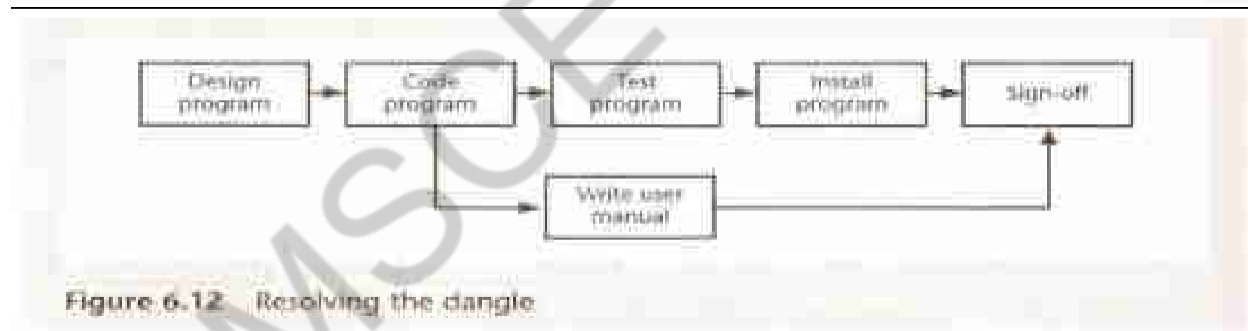

Figure 6.12: Resolving the dangle

Representing lagged activities

We might come across situations where we wished to undertake two activities in parallel so long as there is a lag between the two. We might wish to document amendments to a program as it was being tested - particularly if evaluating a prototype. Where activities can occur in parallel with a time lag between them we represent the lag with duration on the linking arrow as shown in Figure 6.13. This indicates that documenting amendments can start one day after the start of prototype testing and will be completed two days after prototype testing is completed.

Hammock activities

A hammock activity (also hammock task) is a schedule or project planning term for a grouping of tasks that "hang" between two end dates it is tied to. A hammock activity can group tasks which are not related in the hierarchical sense of a Work Breakdown Structure, or are not related in a logical sense of a task dependency where one task

must wait for another.

AMSCCE - 1101

	Labeling conventions	Earliest Start	Estimated Duration	Earliest Finish
		Activity Label, Activity Description		
		Latest Start	Float	Latest Finish

AMSCCE - 1101

10 Explain how you will identify the major risks that might affect your project and identify the strategies for minimizing each of those risks. (Dec 14,18, May 13,15,19)

Risk Evaluation

After the potential risks have been identified, the project team then evaluates the risk based on the probability that the risk event will occur and the potential loss associated with the event. Not all risks are equal. Some risk events are more likely to happen than others, and the cost of a risk event can vary greatly. Evaluating the risk for probability of occurrence and the severity or the potential loss to the project is the next step in the risk management process.

RISK AND IMPACT

1. There is a **positive correlation**—both increase or decrease together—between project risk and project complexity. A project with new and emerging technology will have a high-complexity rating and a correspondingly high risk.
2. The project management team will assign the appropriate resources to the technology managers to assure the accomplishment of project goals. The more complex the technology, the more resources the technology manager typically needs to meet project goals, and each of those resources could face unexpected problems.
3. Risk evaluation often occurs in a workshop setting. Building on the identification of the risks, each risk event is analyzed to determine the likelihood of occurring and the potential cost if it did occur. The likelihood and impact are both rated as high, medium, or low. A risk mitigation plan addresses the items that have high

ratings on both factors – likelihood and impact.

AMSCCE - 1101

RISK ANALYSIS OF EQUIPMENT DELIVERY

1. A project team analyzed the risk of some important equipment not arriving to the project on time. The team identified three pieces of equipment that were critical to the project and would significantly increase the costs of the project if they were late in arriving.
2. One of the vendors, who was selected to deliver an important piece of equipment, had a history of being late on other projects. The vendor was good and often took on more work than it could deliver on time. This risk event (the identified equipment arriving late) was rated as high likelihood with a high impact. The other two pieces of equipment were potentially a high impact on the project but with a low probability of occurring.

RISK MITIGATION

After the risk has been identified and evaluated, the project team develops a risk mitigation plan, which is a plan to reduce the impact of an unexpected event. The project team mitigates risks in the following ways:

- ❖ Risk avoidance
- ❖ Risk sharing
- ❖ Risk reduction
- ❖ Risk transfer

Each of these mitigation techniques can be an effective tool in reducing individual risks and the risk profile of the project. The risk mitigation plan captures the risk mitigation approach for each identified risk event and the actions the project management team will take to reduce or eliminate the risk.

Risk avoidance usually involves developing an alternative strategy that has a higher probability of success but usually at a higher cost associated with accomplishing a project task.

Risk sharing involves partnering with others to share responsibility for the risk activities. Many organizations that work on international projects will reduce political, legal, labor, and others risk types associated with international projects by developing a joint venture with a company located in that country.

Risk reduction is an investment of funds to reduce the risk on a project. On international projects, companies will often purchase the guarantee of a currency rate to reduce the risk associated with fluctuations in the currency exchange rate. A project manager may hire an expert to review the technical plans or the cost estimate on a project to increase the confidence in that plan and reduce the project risk.

Risk transfer is a risk reduction method that shifts the risk from the project to another party. The purchase of insurance on certain items is a risk transfer method. The risk is transferred from the project to the insurance company.

11 **Explain in detail about Monte Carlo Simulation.**

A Monte Carlo method is a technique that involves using random numbers and probability to solve problems. Monte Carlo simulation is a method for iteratively evaluating a deterministic model using sets of random numbers as inputs. This method is often used when the model is complex, nonlinear, or involves

more than just a couple uncertain parameters. A simulation can typically involve over 10,000 evaluations of the model, a task which in the past was only practical using super computers. The Monte Carlo method is just one of many methods for analyzing uncertainty propagation, where the goal is to determine how random variation, lack of knowledge, or error affects the sensitivity, performance, or reliability of the system that is being modeled.

Monte Carlo simulation is categorized as a sampling method because the inputs are randomly generated from probability distributions to simulate the process of sampling from an actual population. So, we try to choose a distribution for the inputs that most closely matches data we already have, or best represents our current state of knowledge. The data generated from the simulation can be represented as probability distributions (or histograms) or converted to error bars, reliability predictions, tolerance zones, and confidence intervals. (See Figure 2).

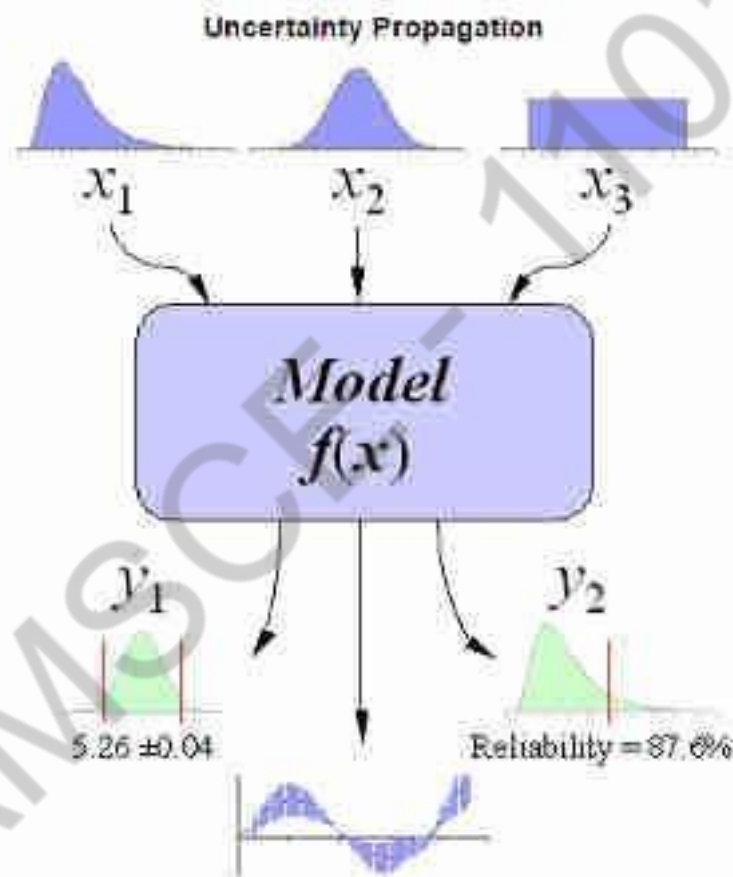

Figure 2: Schematic showing the principal of stochastic uncertainty propagation. (The basic principle behind Monte Carlo simulation.)

The steps in Monte Carlo simulation corresponding to the uncertainty propagation shown in Figure 2 are fairly simple, and can be easily implemented in Excel for simple models. All we need to do is follow the five simple steps listed below:

- Step 1: Create a parametric model, $y = f(x_1, x_2, \dots, x_q)$.
- Step 2: Generate a set of random inputs, $x_{i1}, x_{i2}, \dots, x_{iq}$.
- Step 3: Evaluate the model and store the results as y_i .
- Step 4: Repeat steps 2 and 3 for $i = 1$ to n .
- Step 5: Analyze the results using histograms, summary statistics, confidence intervals,

etc.

AMSCCE - 1101

12 Write short notes on Resource Allocation and Cost Schedule/ What are the seven categories of resources and explain.(Apr 19)

Resource allocation is the assignment of available resources to various uses. In the context of an entire economy, resources can be allocated by various means, such as markets or central planning. In project management, resource allocation or resource management is the scheduling of activities and the resources required by those activities while taking into consideration both the resource availability and the project time.

Nature of Resources

- ❖ Labor - Members of the project team
- ❖ Equipment - Workstations and other communicating and office equipments
- ❖ Material - Items that are consumed
- ❖ Space - Office space
- ❖ Services - Some specialist services telecommunicating
- ❖ Time - Offset against the other primary resource

Identifying Resource Requirements

- ❖ What resources are required along with the expected level of demand
- ❖ Consider each activity
- ❖ Identify required resources

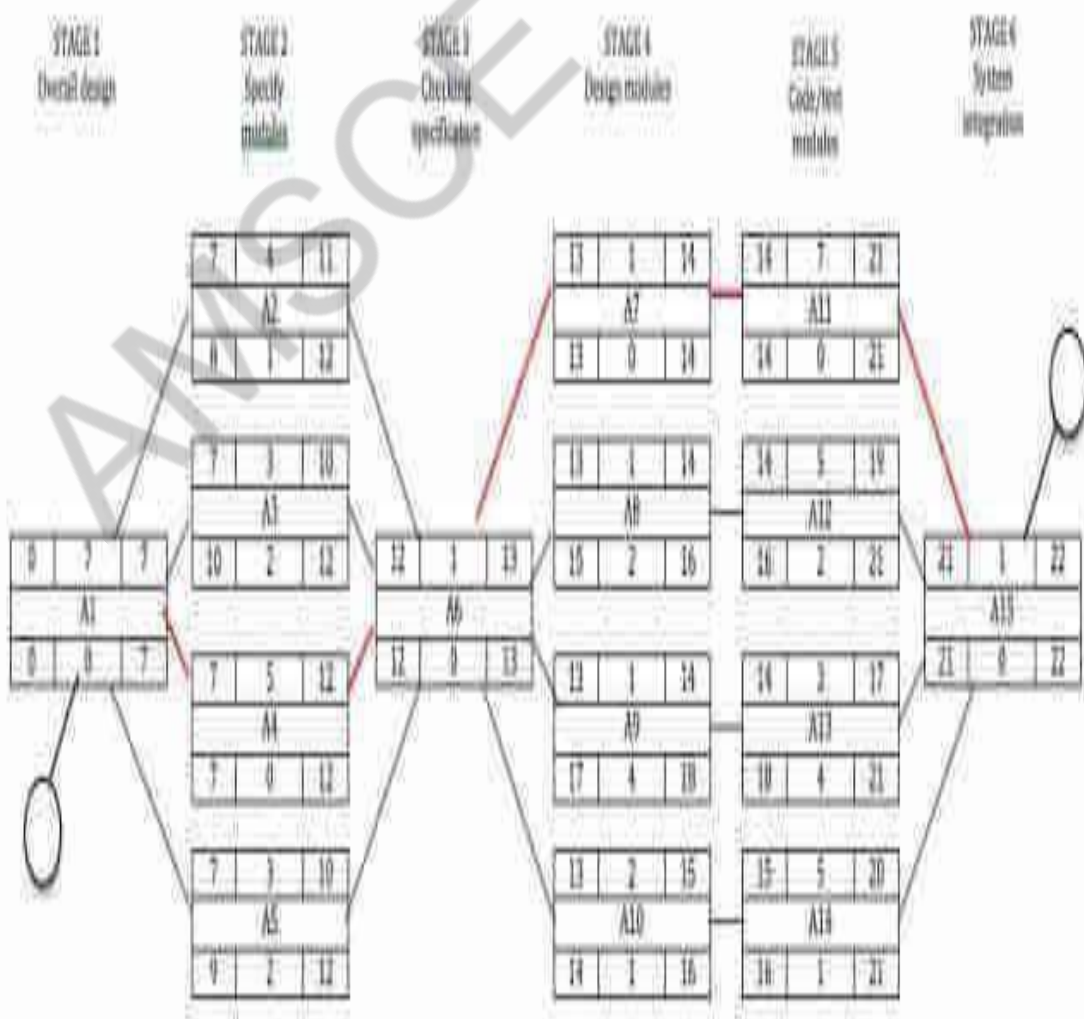

Scheduling Resources

- ❖ Allocating resources for one activity limits flexibility for resource allocation and scheduling of other activities

Priorities resource allocation

- ❖ Total float priority

Activities are ordered according to their total float .Those with the smallest float are assigned the highest priority

Ordered list priority

- ❖ Ordered according to predefined criteria
 - ✓ Shortest critical path - Critical activities
 - ✓ Shortest non-critical activity
 - ✓ Non-critical activity with least float
 - ✓ Non-critical activities

Map on activity plan to assess the distribution of resources required over the duration of the project

- ✓ Recruiting staff has cost
- ✓ Smooth the histogram by delaying the start of some activities

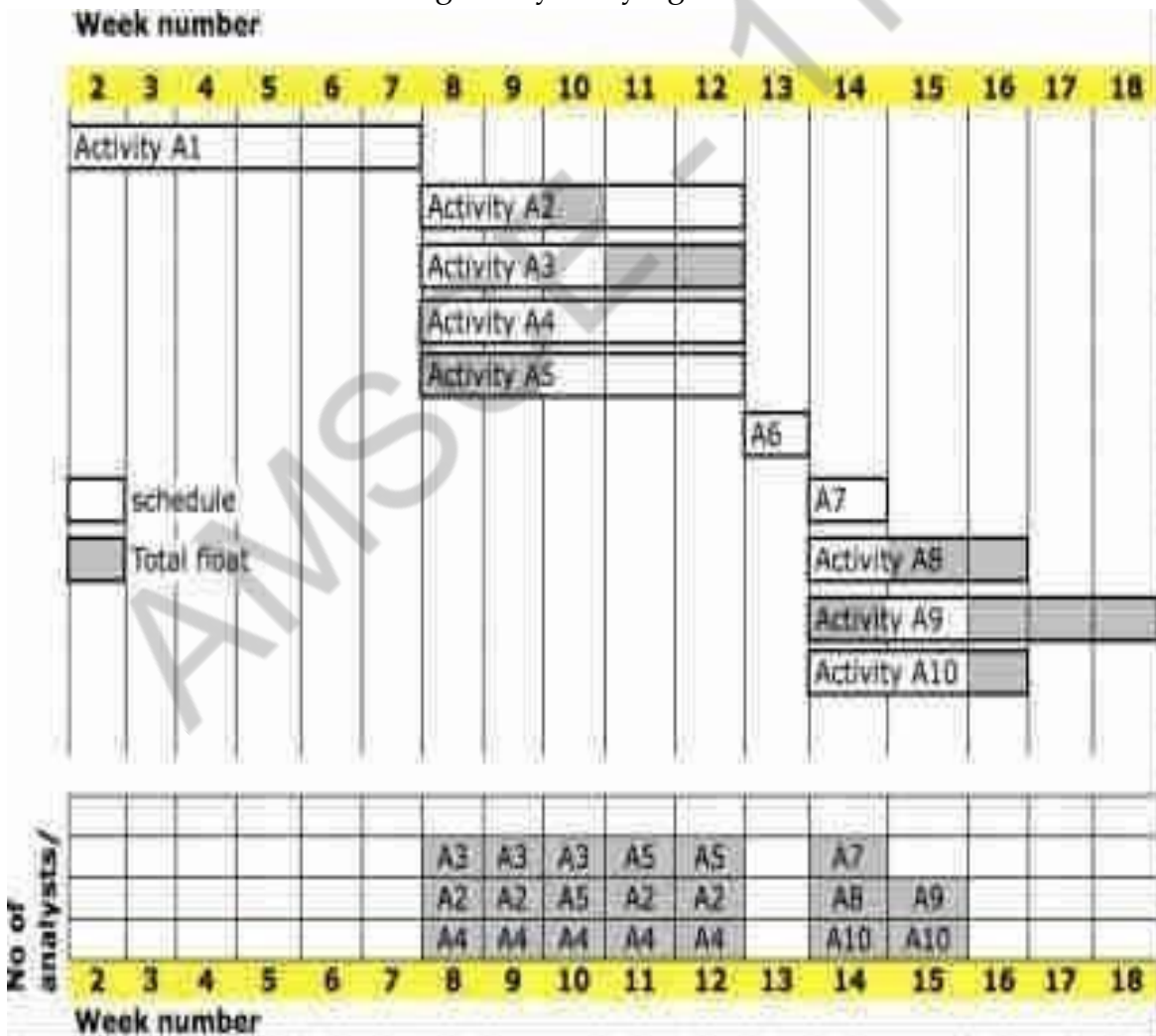

Creating Critical Paths

- ❖ Scheduling resources can create new critical paths
 - ✓ Delaying the start of an activity because of lack of resources will cause that activity

AMSCCE - 1101

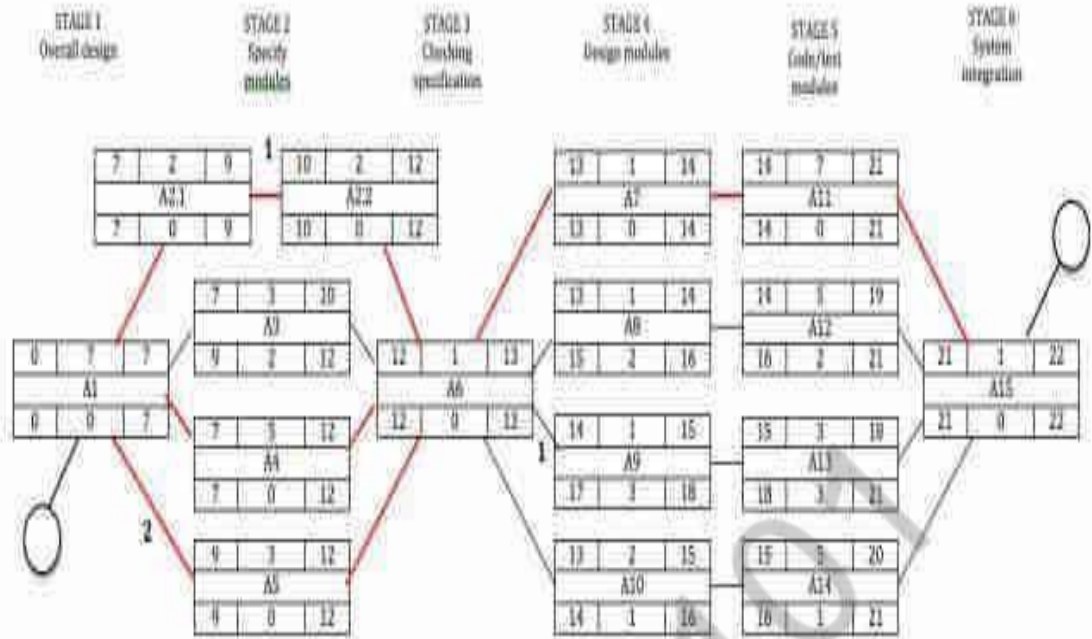

Manage the allocation of resources within programmers

The resources of an organization consist of people, materials, equipment, knowledge and time. Organizations typically have limited resources; therefore, tradeoffs on what project resources are expended and when are made every day within organizations. A resource allocation plan is an important tool in effective management of scarce resources. The timing of the need of those resources can be and should be determined within the project schedules. A resource plan, which describes the type of resource needed and the timing of that need, is critical to effective resource management. As the project schedule changes, the resource plan must also be flexible enough to adjust as these changes occur.

Examples

Allocating resources is fairly self-explanatory. If allocating stone for building a house, the project manager must ensure that she procures enough stone to complete the project. Regarding leveling, if renting equipment, the project manager must ensure it will be used steadily rather than sporadically rented and returned. If contracting carpenters, the project manager should aim to strive to keep a set number of carpenters working at a set number of hours for the duration of the project to ensure consistency. Carpenters may have difficulty scheduling more sporadic hours into their schedule, meaning the firm might then have to contract more workers, leading to inconsistent results. Meanwhile, materials don't necessarily need to be leveled as they have been purchased rather than rented or paid by the hour.

Cost Schedules

- ❖ Calculating cost is straightforward where organization has standard cost figures for staff and other resources. Staff costs includes not just salary, but also social security contributions by the employer, holiday pay etc. Timesheets are often used to record actual hours spent on each project by an individual. One issue can be how time when a staff member is allocated and available to the project, but is not actually working on the

project, is dealt with. Overheads e.g. space rental, service charges etc. Some overheads

AMSCCE - 1101

might be directly attributable to the project, in other cases a percentage of departmental overheads may be allocated to project costs. Usage charges are some charges can be on a 'pay as you go' basis e.g. telephone charges, postage, car mileage - at the planning stage an estimate of these may have to be made.

Cost profile

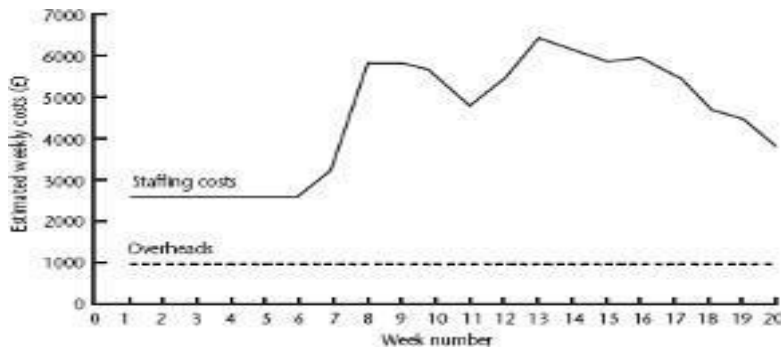

This shows how much is going to be spent in each week. This could be important where an organization allocates project budgets by financial year or quarter and the project straddles more than one of these financial periods

Accumulative costs

The project manager will also be concerned about planned accumulative costs. This chart can be compared to the actual accumulative costs when controlling the project to assess whether the project is likely to meet its cost targets.

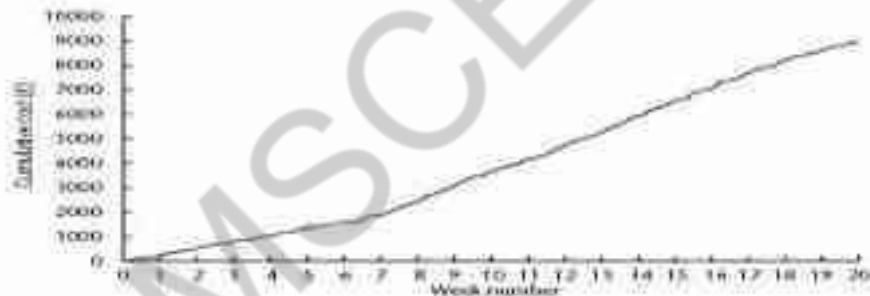

Balancing concerns

Successful project scheduling is not a simple sequence. Because of the inter-linking of different concerns project planning will need to be iterative. The consequences of decisions will need to be carefully assessed and plans adjusted accordingly.

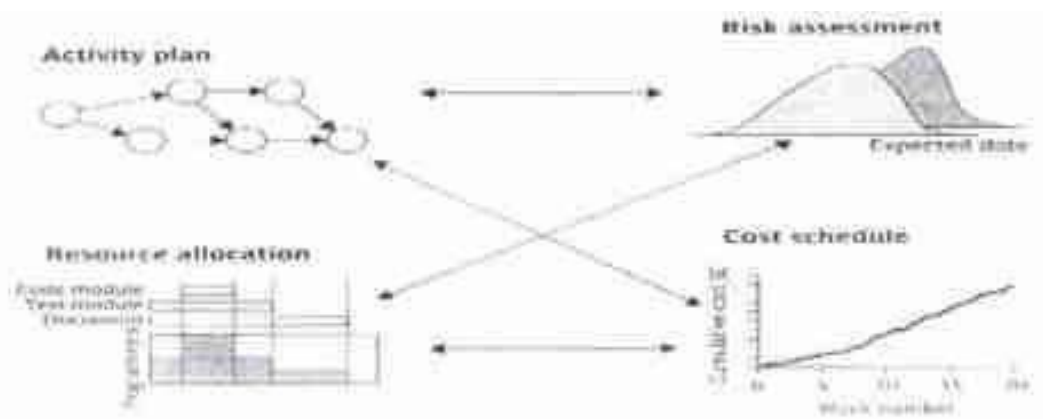

UNIT IV PROJECT MANAGEMENT AND CONTROL

Framework for Management and control - Collection of data Project termination - Visualizing progress - Cost monitoring - Earned Value Analysis- Project tracking - Change control- Software Configuration Management - Managing contracts - Contract Management.

PART-A

1	<p>What are the categories of reporting?</p> <ul style="list-style-type: none"> ✓ Oral formal regular: Weekly or monthly progress meetings ✓ Oral formal ad hoc: End-of-stage meetings ✓ Written formal regular: job sheets, progress reports ✓ Written formal ad hoc: Exception reports, change reports ✓ Oral informal ad hoc: Canteen discussion, social interaction
2	<p>What are the activities that are carried out in project termination process?</p> <ul style="list-style-type: none"> ✓ Project survey ✓ Collection of objective information ✓ Debriefing meeting ✓ Final project review ✓ Result publication
3	<p>What are the reasons for project termination?</p> <ul style="list-style-type: none"> ✓ Project is completed successfully and handed over to the customer. ✓ Incomplete requirements ✓ Lack of resources ✓ Some key technologies used in the project have become obsolete during project execution. ✓ Economics of the project has changed.

4 Draw the project control cycle model.(May 13)

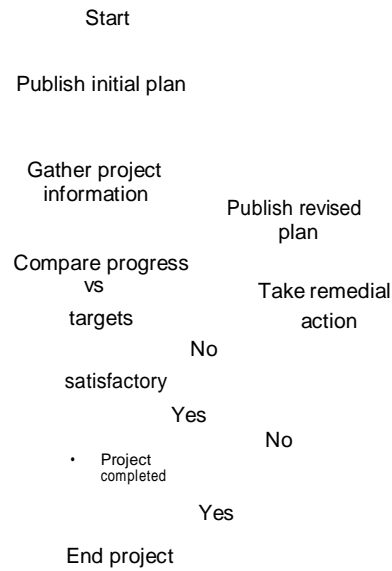

A

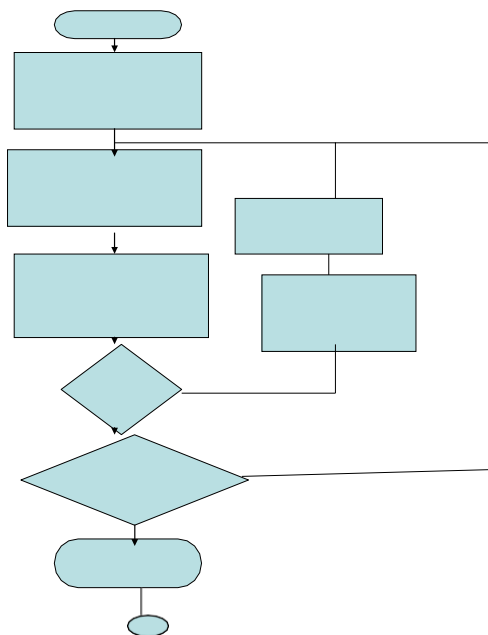

<p>5</p>	<p>Draw the project reporting structures.</p>
<p>6</p>	<p>What is the use of check points in monitoring? (Dec 12) It is essential to set a series of checkpoints in the initial activity plan. Checkpoints may be regular, tied to specific events such as production of a report or other deliverable.</p>
<p>7</p>	<p>Name the popular visual tools used for monitoring and tracking the project progress/ How to visualize progress(Dec 12, May 12,13,18)</p> <ul style="list-style-type: none"> ✓ Gantt chart ✓ Slip chart ✓ Timeline ✓ Ball chart
<p>8</p>	<p>What is Gantt chart?</p> <ul style="list-style-type: none"> ✓ One of the simplest and oldest techniques for tracking project progress. An activity bar chart indicating scheduled activity dates and durations. Reported progress is recorded on the chart by shading activity bars. Today cursor provides visual indication of which activities are ahead or behind schedule. ✓ Disadvantage: do not show clearly the slippage of the project completion date through the life of the project.
<p>9</p>	<p>What is slip chart? Mention its use. (Dec 14)</p> <p>A slip chart is a very alternative favored by some project managers who believe it provides a more striking visual indication of those activities that are not progressing to schedule-the more the slip line bends, the greater variation from the plan. Additional slip lines are added at intervals and, as they built up, the project manager will gain an idea to whether the project is improving or not. A very jagged line indicates a need for rescheduling.</p>

10	<p>What is the timeline chart?</p> <ul style="list-style-type: none">✓ The timeline chart is a method of recording and displaying the way in which targets have changed throughout the duration of the project.✓ Planned time is plotted along the horizontal axis and elapsed time down the vertical axis. <p style="padding-left: 40px;">The lines meandering down the chart represent scheduled completion dates</p>
----	---

AMSCCE - 1101

11	<p>State Earned value analysis (May 14,18,Dec 18)</p> <ul style="list-style-type: none"> ✓ Earned value analysis is based on assigning a value to each task or work package based on the original expenditure forecasts. ✓ The assigned value is the original budgeted cost for the item and is known as the planned value (PV) or budgeted cost of work scheduled (BCWS) ✓ The total value credited to a project at any point is known as the earned value (EV) or budgeted cost of work performed (BCWP)
12	<p>List the methods for assigning an earned value in earned value analysis (Dec 11,19)</p> <ul style="list-style-type: none"> ✓ The 0/100 technique: where a task is assigned a value of zero until that is completed when it is given a value of 100 %. ✓ The 50/50 technique: where a task is assigned a value of 50 % until that is completed when it is given a value of 100 %. ✓ The 75/25 technique: where a task is assigned a value of 75 % until that is completed when it is given a value of 100 %. ✓ The milestone technique: Where a task is given a value based on the achievement of milestones. ✓ The percentage complete: where a task is given a value based on the amount of work completed.
13	<p>What forms the basis for cost performance measurement using Earned Value?</p> <p>Three quantities form the basis for cost performance measurement using Earned Value Management. They are</p> <ul style="list-style-type: none"> ✓ Budgeted Cost of Work Scheduled (BCWS) or Planned Value (PV) ✓ Budgeted Cost of Work Performed (BCWP) or Earned Value (EV) and ✓ Actual Cost of Work Performed (ACWP) or Actual Cost (AC).
14	<p>Define Software Configuration Management</p> <p>Software configuration management (SCM) is a software-engineering discipline comprising the tools and techniques (processes or methodology) that a company uses to manage change to its software assets.</p>
15	<p>What are the two principal activities in configuration management process?</p> <ul style="list-style-type: none"> ✓ Configuration Identification and Configuration Control
16	<p>Why Software Configuration Management in a project is essential?</p> <p>The following are some problems that can occur if a proper configuration management System is not used.</p> <ul style="list-style-type: none"> ✓ Problems associated with concurrent access ✓ Undoing changes ✓ System accounting ✓ Handling variants ✓ Accurate determination of project status ✓ Preventing unauthorized access to the work products.

17	Define Configuration Identification. Configuration identification involves deciding which parts of the system should be kept under configuration management. Project managers normally classify the work products associated with a software development process into three main categories controlled, pre-controlled and uncontrolled.
----	--

AMSCCE - 1101

18	<p>Define Configuration Control. (Nov/Dec 2019)</p> <p>Configuration Control is part of a configuration management system that most directly affects the day-to-day operations of developers. This activity is used to ensure that the changes to a system occur smoothly.</p>
19	<p>How work products are classified in software development process?</p> <ul style="list-style-type: none"> ✓ Controlled ✓ Pre-controlled ✓ uncontrolled
20	<p>Define managing contracts. (Nov/Dec 2018)</p> <ul style="list-style-type: none"> ✓ Contract management or contract administration is the management of contracts made with customers, vendors, partners, or employees. ✓ Contract management includes negotiating the terms and conditions in contracts and ensuring compliance with the terms and conditions, as well as documenting and agreeing on any changes that may arise during its implementation or execution. ✓ It can be summarized as the process of systematically and efficiently managing contract creation, execution, and analysis for the purpose of maximizing financial and operational performance and minimizing risk.
21	<p>Define BCWP, BCWS.</p> <p>The total value credited to a project at any point is known as the earned value or budgeted cost of work performed(BCWP) and this can be represented as a value or as a percentage of the BCWS</p>
22	<p>What is budget variance?</p> <p>Budget variance can be calculated as ACWP-BCWS and indicates the degree to which actual costs differ from those planned where the actual cost of each task can be collected as actual cost of work performed (ACWP).</p>
23	<p>What are the types of contract?</p> <ul style="list-style-type: none"> ✓ Fixed Price Contracts ✓ Time And Materials Contracts ✓ Fixed Price Per Unit Delivered Contracts
24	<p>List out the contract for a completed software package.</p> <ul style="list-style-type: none"> ✓ Bespoke system-It's a system that is created from scratch specifically for one customer. ✓ Off-the-shelf-this is sometimes referred to as shrink wrapped software. ✓ Customized Off-the-shelf (COTS) software-this is a basic core system, which is modified to meet the needs of a particular customer.
25	<p>Define fixed price contracts.</p> <p>The price is fixed when the contract is signed. If there are no changes in the contract terms, this is the price they pay on completion. When the contract is to construct a software system, the detailed requirements analysis must already have been carried out. Once the development is under way the customer cannot change their requirements without renegotiating the price of the contract.</p>

26	<p>List the advantages of fixed price contracts.</p> <ul style="list-style-type: none"> ✓ Known customer expenditure ✓ Supplier motivation ✓ Higher prices to allow for contingency ✓ Difficulties in modifying requirements ✓ Upward pressure on the cost of changes. ✓ Threat to system quality
27	<p>List the advantages of time and materials contracts.</p> <ul style="list-style-type: none"> ✓ Ease of changing requirements and Lack of price pressure
28	<p>List the disadvantages of fixed price contracts.</p> <ul style="list-style-type: none"> ✓ Higher prices to allow for contingency ✓ Difficulties in modifying requirements ✓ Upward pressure on the cost of changes ✓ Threat to system quality
29	<p>Define time and materials contracts.</p> <p>In time and material contracts the customer is charged at a fixed rate per unit of effort, for ex per staff-hour. The supplier may provide an initial estimate of the cost based on their current understanding of the customer's requirements, but this is not the basis for final payment.</p>
30	<p>List the disadvantages of time and materials contracts.</p> <ul style="list-style-type: none"> ✓ Customer liability ✓ Lack of incentives for supplier
31	<p>Define fixed price per unit delivered contracts.</p> <p>This is associated with function point (FP) counting. The size of the system to be delivered is calculated or estimated at the outset of the project. The size could be estimated in lines of code, but FPs can be more easily derived from requirements documents.</p>
32	<p>List the disadvantages of fixed price per unit delivered contracts.</p> <ul style="list-style-type: none"> ✓ Difficulties with software size measurement ✓ Changing requirements
33	<p>List the advantages of fixed price per unit delivered contracts.</p> <ul style="list-style-type: none"> ✓ Customer understanding ✓ Comparability pricing schedules ✓ Emerging functionality ✓ Supplier efficiency ✓ Life-cycle range
34	<p>What is the process of Evaluation?</p> <ul style="list-style-type: none"> ✓ Scrutiny of the proposal documents ✓ Interviewing suppliers representatives ✓ Demonstration ✓ Site Visits ✓ Practical tests.

AMSCE - 1101

1 Explain the framework for Management and control in detail.

CREATING THE FRAMEWORK

Exercising control over a project and ensuring that targets are met is a matter of regular monitoring, finding out what is happening, and comparing it with current targets. If there is a mismatch between the planned outcomes and the actual one then either preplanning is needed to bring the project back on target or the target will have to be revised. A model of the project control cycle is illustrated in Figure 6.1

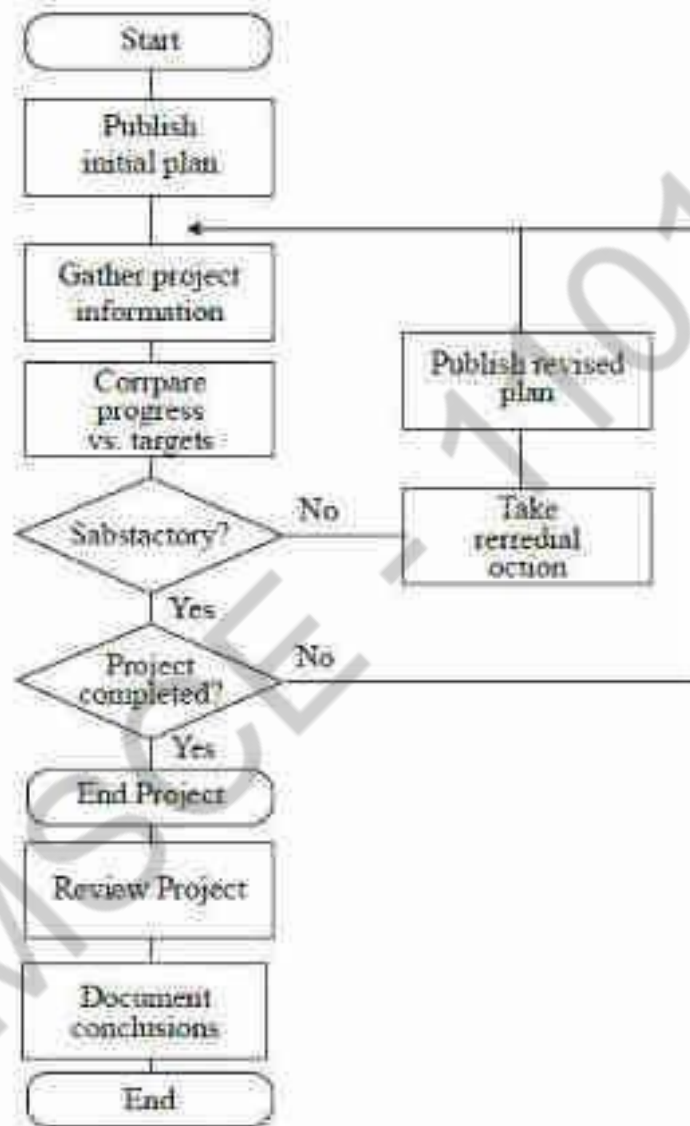

Figure 6.1: The Project Control Cycle

Responsibility:

The overall responsibility for ensuring adequate progress on a project is often the role of the project-steering committee or Project Board. Day-to-day responsibility will be with the project manager and, in all but the smallest of projects; aspects of this can be delegated to team leaders. Figure 6.2 illustrates the typical reporting structure found with medium and large projects. With small projects employing less number of staff individual team members usually report directly to the project manager. But in most

cases team leaders will collate reports on their section’s progress and forward summaries to the project manager. These, in turn, will be incorporated into project-level reports for the steering committee and, via them or directly, progress reports for the client. Reporting may be oral or written, formal or informal, or regular or ad hoc. Some examples of each type are tabulated in Table 6.1.

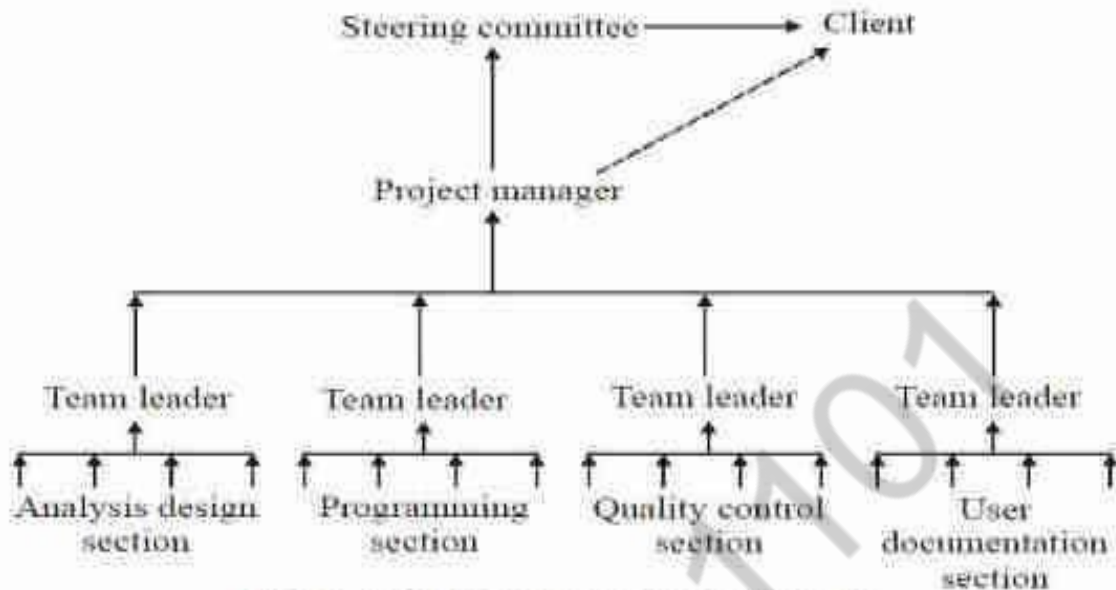

Figure 6.2: Project Reporting Structure

With small projects employing less number of staff individual team members Usually report directly to the project manager. But in most cases team leaders will collate reports on their section’s progress and forward summaries to the project manager. These, in turn, will be incorporated into project-level reports for the steering committee and, via them or directly, progress reports for the client. Reporting may be oral or written, formal or informal, or regular or ad hoc. Some examples of each type are tabulated in Table 6.1.

Table 6.1: Categories of Reporting

Report Type	Examples	Comment
Oral formal regular	Weekly or monthly progress meetings	While reports may be oral formal written minutes should be kept
Oral formal ad hoc	End-of-stage review meetings	While largely oral, likely to receive and generate written reports
Written formal regular	Job sheets, Progress reports	Normally weekly using forms
Written formal ad hoc	Exception reports, Change reports	
Oral informal ad hoc	Canteen discussion, Social interaction	Often provides early warning, must be backed up by formal reporting

	<p>Assessing the Progress</p> <ul style="list-style-type: none"> ❖ Progress assessment will be made on the basis of information collected and collated at regular intervals or when specific events occur. ❖ Wherever possible, this information will be objective and tangible - whether or not a particular report has been delivered. ❖ Progress assessment will have to rely on the judgment of the team members who are carrying out the project activities. <p>Setting Checkpoints</p> <p>A series of checkpoints in the initial activity plan need to be set. Checkpoints maybe:</p> <ul style="list-style-type: none"> ❖ Regular (Daily, for example) ❖ Tied to specific events such as the production of a report or other deliverable <p>Taking Snapshots</p> <ul style="list-style-type: none"> ❖ The frequency with which a manager needs to receive information about progress will depend upon the size and degree of risk of the project or that part of the project under their control. ❖ Team leaders, for example, need to assess progress daily whereas project managers may find weekly or monthly reporting appropriate. ❖ In general, the higher the level, the less frequent and less detailed the reporting needs to be. A formal weekly collection of information from staff carrying out activities is favored.
<p>2</p>	<p>Discuss in detail about collection of data/For a software project, draw an activity chart with task dependency table. Derive the critical path for completion of the project based on task dependency table. Derive critical path for completion of the project. Based on task dependency diagram allocate resource and derive Activity Chart. (Nov/Dec 18)</p> <p>DATA COLLECTION</p> <p>Managers will try to break down long activities into more controllable tasks of one or two weeks' duration. However, it will still be necessary to gather information about partially completed activities and, in particular, forecasts of how much work is left to be completed. It may be difficult to make such forecasts accurately.</p> <p>Where there is a series of products, partial completion of activities is easier to estimate. Counting the number of record specifications or screen layouts produced, for example, can provide a reasonable measure of progress.</p> <p>Partial Completion Reporting</p> <p>All organizations use standard accounting systems with weekly timesheets to charge staff time to individual jobs. The staff time booked to a project indicates the work carried out and the charges to the project. However, it does not, tell the project manager what has been produced or whether tasks are on schedule. It is therefore common to adapt or enhance existing accounting data collection systems to meet the needs of project control. Weekly time sheets, for example, are frequently adapted by breaking jobs down to activity level and requiring information about work done in addition to time spent. Figure 6.3 illustrates a typical example of such a report form, in this case</p>

requesting information about likely slippage of completion dates as well as estimates of completeness. Asking for estimated completion times frequently should be avoided as this may affect the importance of the originally scheduled targets.

AMSCCE - 1101

TIME SHEET						
Staff		LOKESH S		Week Ending		30/3/11
Rechargeable hours						
Project	Activity Code	Description	Hours This Week	% Complete	Scheduled Completion	Estimated Completion
P21	A243	Code Module A3	12	30	24/4/07	24/4/07
P34	B377	Document take-on	20	80	6/4/07	4/4/07
Total Recharged Hours			32			
Non-Rechargeable Hours						
Code	Description	Hours This Week	Comment and Authorization			
/99	Day in Liek	8	Authorized by John Prakash			
Total Non-Rechargeable Hours			8			

Figure 6.3: A Weekly Timesheet and Progress Review Form

Risk Reporting

One method overcoming the objections to partial completion reporting is to avoid asking for estimated completion dates, but to ask instead for the team members' estimates of the likelihood of meeting the planned target date. One way of doing this is the traffic light method. This consists of the following steps:

- ❖ Identify the key elements for assessment in a piece of work (first level)
- ❖ Break these key elements into constituent elements (second level)
- ❖ Assess each of the second-level elements on the scale green for 'on target', amber for 'not on target but recoverable', and red for 'not on target and recoverable only with difficulty'
- ❖ Review all the second level assessments to arrive at first level assessments
- ❖ Review first and second level assessments to produce an overall assessment

Each activity is broken into a number of component parts and deciding whether a further breakdown is needed and get the team members to complete a return at the end of each week.

Traffic-light assessment highlights only risk of non-achievement; it is not an attempt to estimate work done or to quantify expected delays. Following completion of assessment forms for all activities, the project manager uses these as a basis for

evaluating the overall status of the project. Any critical activity classified as amber or

AMSCCE - 1101

red will require further consideration and often leads to a revision of the project schedule. Non-critical activities are likely to be considered as a problem if they are classified as red, especially if their entire float is likely to be consumed. The same is illustrated in Figure 6.4.

ACTIVITY ASSESSMENT SHEET							
Staff	LINI						
Ref: KoE/P/12	Activity: Code and test module C						
Week Number	13	14	15	16	17	18	
Activity Summary	G	A	A	R			
Component							Comments
Screening Handling	G	A	A	G			
File Update Procedures	G	G	R	A			
Housekeeping Procedures	G	G	G	A			
Compilation	G	G	G	R			
Test Data Runs	G	G	G	A			
Program Documentation	G	G	A	R			

Figure 6.4: Example for a Traffic Light Assessment

- 3 Explain the various methods for visualizing the progress of a project. / Analyze the methods used for project tracking. (Dec 12,18,19,May 13,15,18,19)

VISUALIZING PROGRESS

Once data has been collected about project progress, a manager needs some way of presenting that data to greatest effect. Some of these methods such as Gantt charts provide a static picture, a single snapshot, whereas others such as time line charts try to show how the project has progressed and changed over time.

The Gantt Chart

Gantt chart is a technique used for tracking project progress. This is essentially an activity bar chart indicating scheduled activity dates and durations frequently augmented with activity floats. Reported progress is recorded on the chart by shading activity bars and a 'today cursor' provides an immediate visual indication of which activities are ahead or behind schedule. Figure 6.5 shows an example of Gantt chart as at the end of Tuesday of week 17.

'Code & test module D' has been completed ahead of schedule and 'Code & test module A' appears also to be ahead of schedule. The coding and testing of the other two modules are behind schedule.

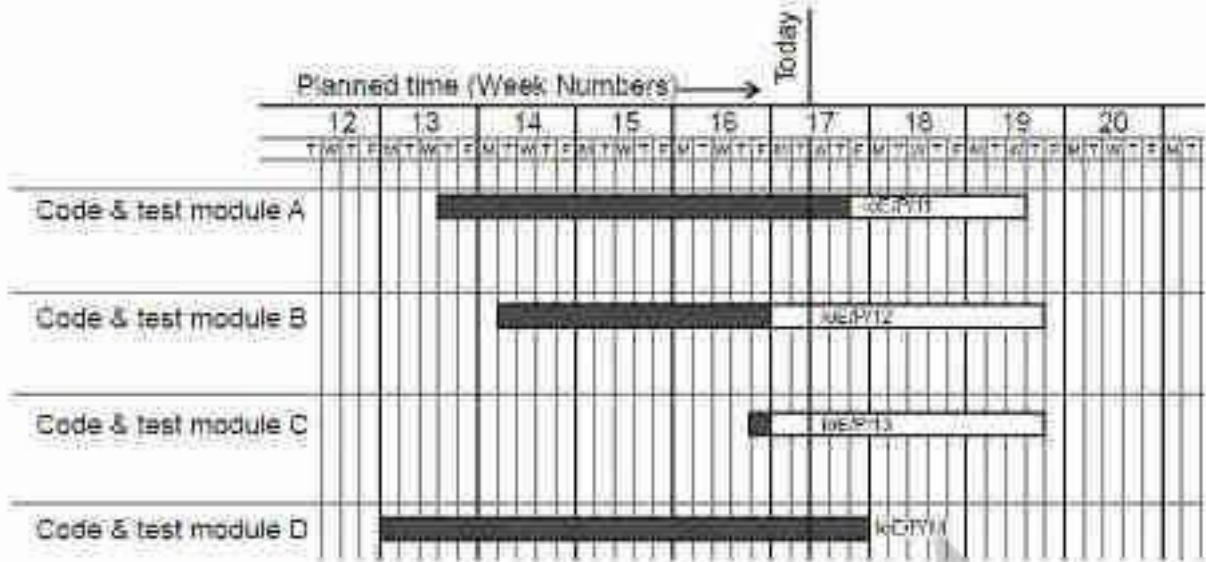

Figure 6.5: Gantt Chart with the 'Today Cursor' in Week 17

The Slip Chart

A slip chart illustrated in Figure 6.6 is an alternative favored by some project managers who believe it provides a more striking visual indication of those activities that are not progressing to schedule. The more the slip line bends, the greater the variation from the plan. Additional slip lines are added at intervals and, as they build up, the project manager will gain an idea as to whether the project is improving subsequent slip lines bend less or not. A very jagged slip line indicates a need for rescheduling.

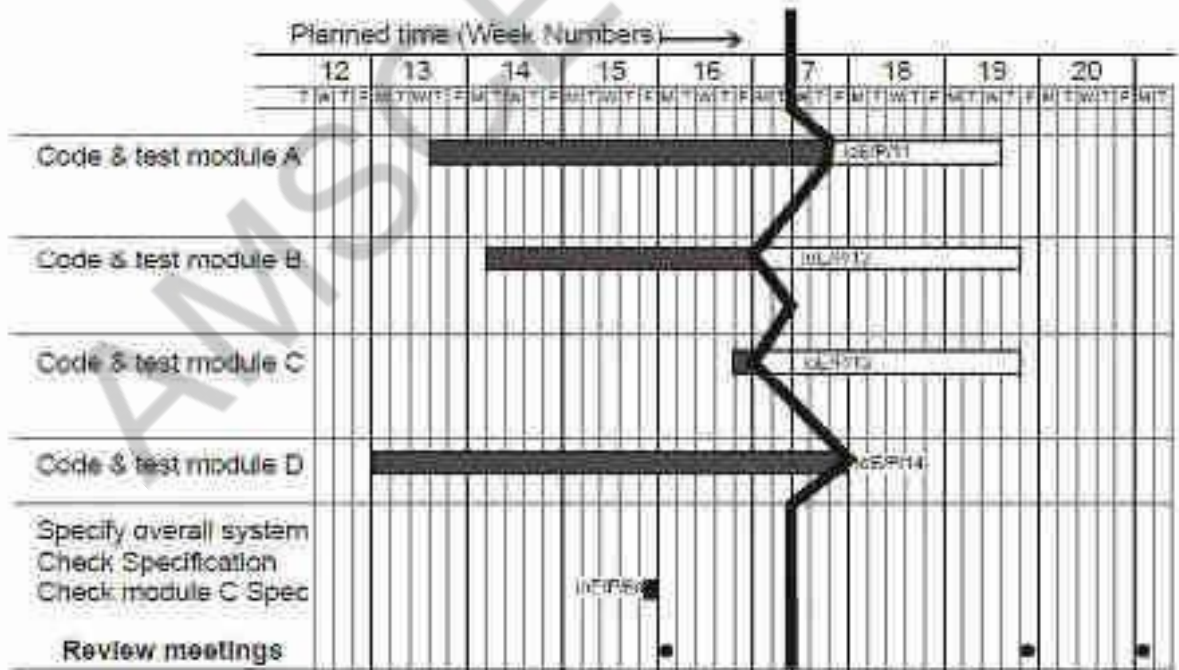

Figure 6.6: Slip Chart illustrating the Relative Position of Each Activity

Ball Charts

A more prominent way of showing whether or not targets have been met is to use a ball chart. The same is illustrated in Figure 6.7. In this version of the ball chart, the circles indicate start and completion points for activities. The circles initially contain the

original scheduled dates. Whenever revisions are produced, these are added as second

AMSCCE - 1101

dates in the appropriate circle until an activity is actually started or completed, when the relevant date replaces the revised estimate (in bold italic in Figure 6.7).

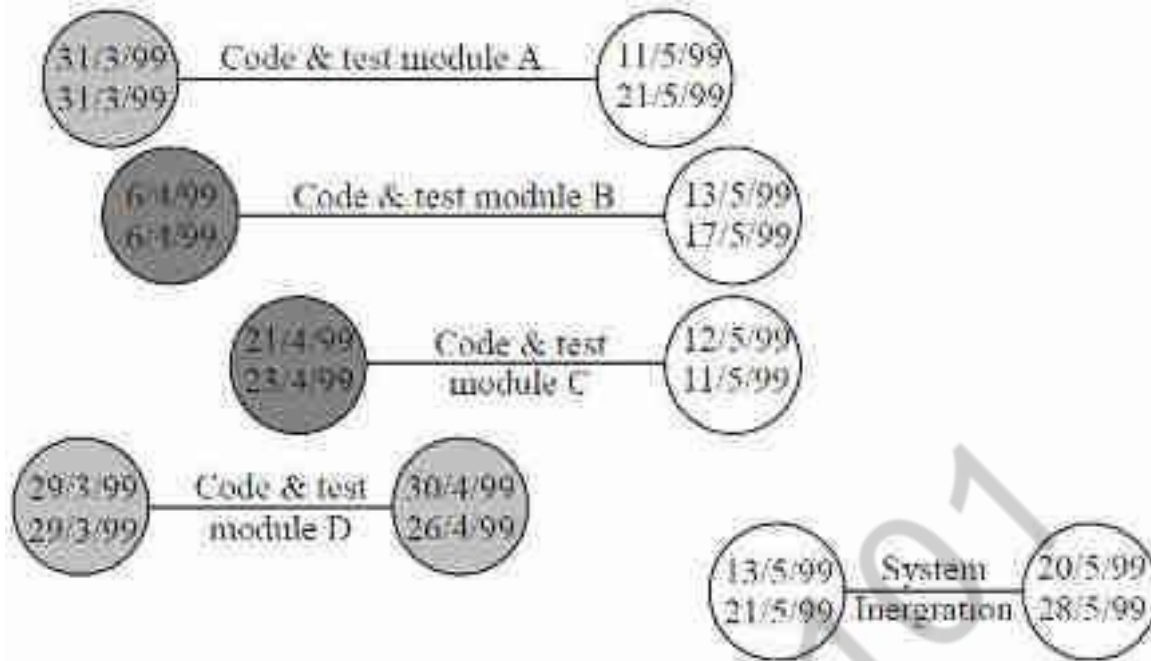

Figure 6.7: Example for Ball Chart

Circles will contain only two dates, the original and most recent target dates, or the original and actual dates. Where the actual start or finish date for an activity is later than the target date, the circle is colored red (dark grey in Figure 6.7) - where an actual date is on time or earlier than the target then the circle is colored green (light grey in Figure 6.7). Such charts are frequently placed in a prominent position and the color-coded balls provide a constant reminder to the project team. Where more than one team is working in close proximity, such a highly visible record of achievement can encourage competitiveness between teams.

Another advantage of ball charts over Gantt and slip charts is that they are relatively easy to keep up to date. Only the dates and possibly colors need to be changed, whereas the others need to be redrawn each time target dates are revised.

The Timeline

One major disadvantage of Gantt chart, Slip chart and Ball chart is that they do not show clearly the slippage of the project completion date through the life of the project. Knowing the current state of a project helps in revising plans to bring it back on target, but analyzing and understanding trends helps to avoid slippage in future projects. The timeline chart is a method of recording and displaying the way in which targets have changed throughout the duration of the project.

Figure 6.8 illustrates a timeline chart for a project at the end of the sixth week. Planned time is plotted along the horizontal axis and elapsed time down the vertical axis. The lines meandering down the chart represent scheduled activity completion date. During the start of the project 'analyze existing system' is scheduled to be completed by the Tuesday of week 3, 'obtain user requirements' by Thursday of week 5, 'issue tender',

the final activity, by Tuesday of week 9, and so on.

AMSCCE - 1101

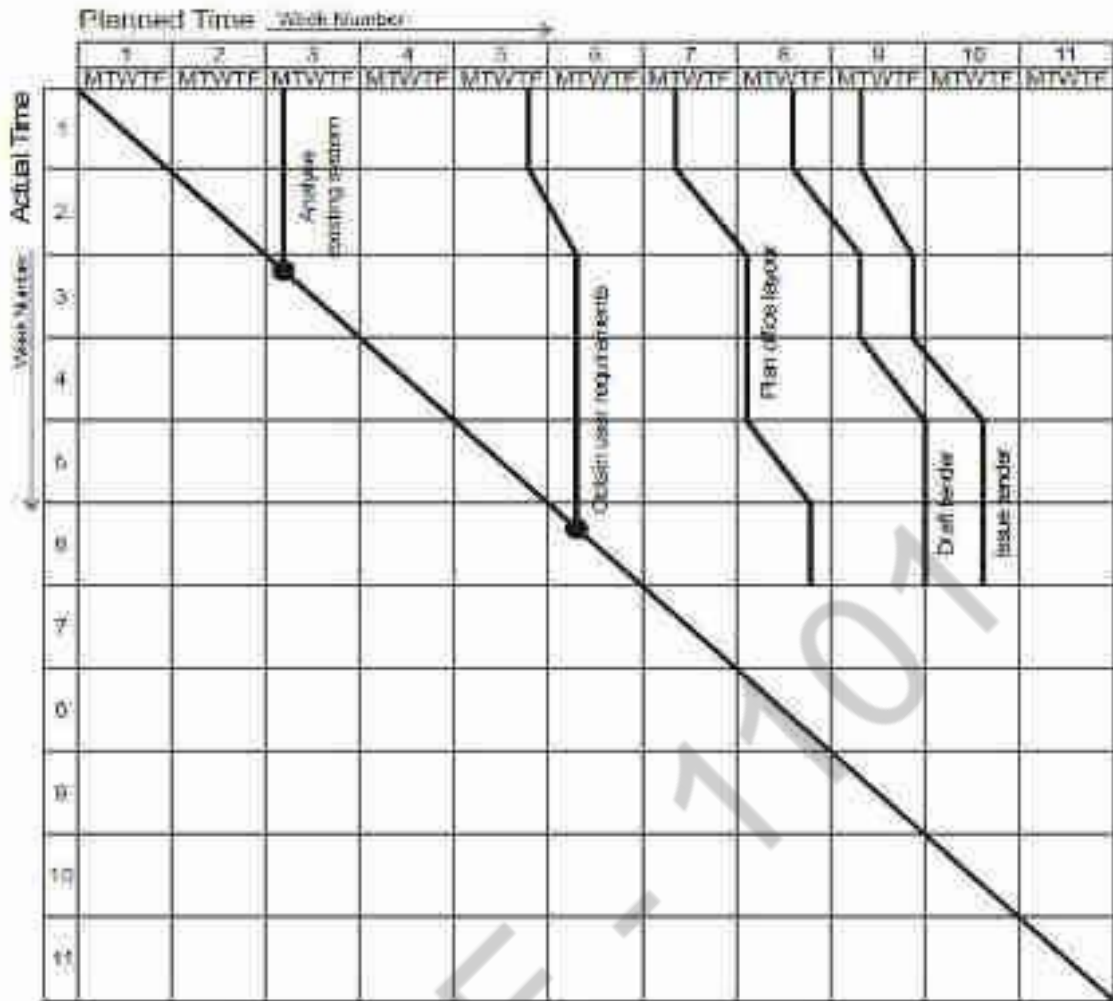

Figure 6.8: Example for Time Line Chart

At the end of the first week the project manager reviews these target dates and leaves them as they are - lines are therefore drawn vertically downwards from the target dates to the end of week one on the actual time axis. At the end of week 2, the project manager decides that 'obtain user requirements' will not be completed until Tuesday of week 6. So the project manager therefore extends that activity line diagonally to reflect this. The other activity completion targets are also delayed correspondingly. By the Tuesday of week 3, 'analyze existing system' is completed and the project manager puts a blob on the diagonal timeline to indicate that this has happened. At the end of week 3 the project manager decides to keep to the existing targets. At the end of week 4 the project manager adds another three days to 'draft tender' and 'issue tender'.

4 Give the importance of cost monitoring in detail.

COST MONITORING

Expenditure monitoring is a vital component of project control because it provides an indication of the effort that has gone into a project. A project might be on time but only because more money has been spent on activities than originally budgeted. A cumulative expenditure chart such as that shown in Figure 6.9 provides a simple method of comparing actual and planned expenditure. Figure 6.9 illustrates a project that is running late or one that is on time but has shown substantial costs savings. The current status of the project activities has to be taken into account before attempting to interpret the meaning of recorded expenditure. Cost charts become useful if we add

AMSCCE - 1101

projected future costs calculated by adding the estimated costs of uncompleted work to the costs already incurred. Where a computer based planning tool is used, revision of cost schedules is generally provided automatically once actual expenditure has been recorded.

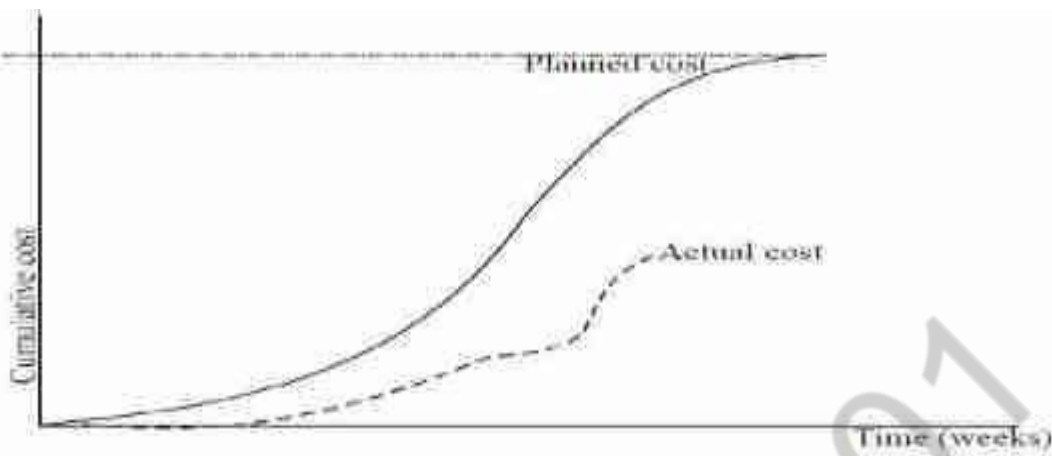

Figure 6.9: Tracking Cumulative Expenditure

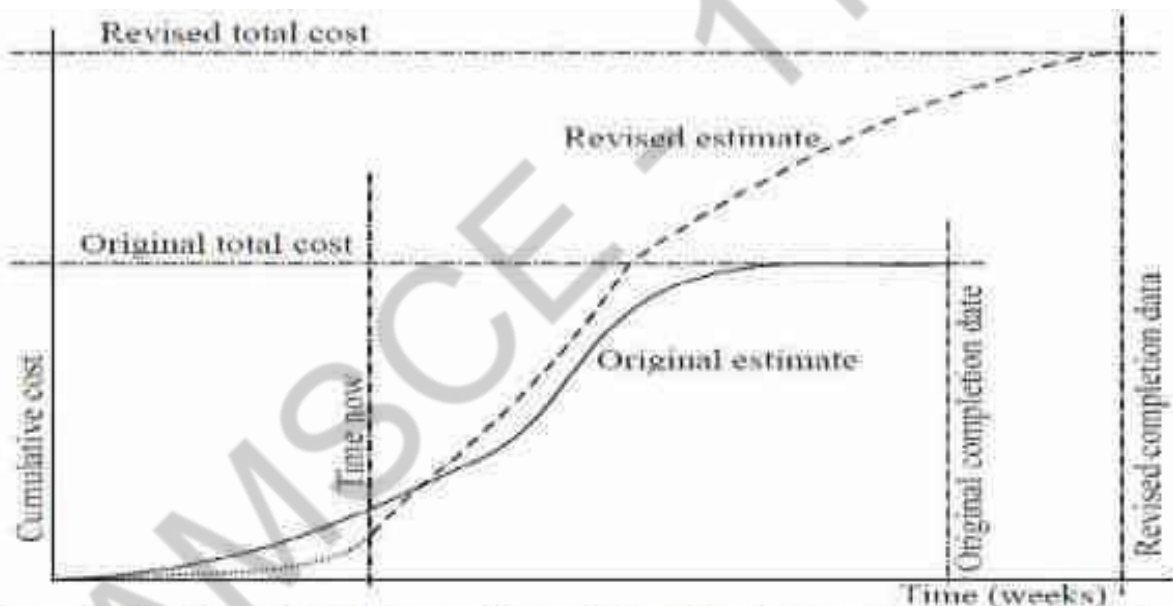

Figure 6.10: Cumulative Expenditure Chart Illustrating Revised Estimates of Cost and Completion Date

Project Management

Project management may be viewed as the process of consolidating different components of the a project activities under a Project Manager for the purpose of effective control to accomplish predefined management objective(s) within budget and set time. It is vital to appreciate that a “project” is usually not part of normal business activities or operations; it is a one-off or an impermanent activities with time boundary. Hence, a project is a temporary company or an organization’s activities designed to accomplish a distinctive Values, development, Products, Service or result with a defined beginning and end which usually may be constrained by funding, time, deliverables, force majeure or political atmosphere crucial to meet your company goals and objectives, which will bring about the needed development and growth. That’s

why it is very crucial to plan it properly and allocate the right resources and materials early on. Any mistake in the planning process can result to delays, or budget overrun or the non-completion of the project (at set time).

Project Definition

This is where the expectation or goal of the project management objective is developed and defined without any ambiguity. This phase also involves setting realistic expectations and identifying all the potential constraints that will be planned against to mitigate. All the stakeholders in a project including the Board (if applicable), the CEO, Management Team, Consultant (if required), project manager, his team and client (if applicable) must be involved in defining the project.

Project Planning

This is to plan on how best to achieve the set goal as defined above. It includes selecting and designating people to appropriate roles, allocating resources, develop project time-line/durations and setting milestones. The project manager should also analyze how long each task will take to complete and how it will affect the deadline. Additional staff can be assigned to work at the critical points of the project if this is required.

Project Execution

Here involves implementing the above plan that has been developed by the project manager and other stakeholders. The project manager has to manage the project constraints such as the budget, people, schedule, and project scope effectively. Each team member must start working on the tasks that were assigned to them.

Project Control

To ensure that the project is progressing properly, there must be controls in place. The project manager must know the details of the project's progress. Team members must submit a report of whenever milestones are completed. This facilitates the effective administration of the project.

Project Completion

If the project meets expectations are met within the defined timeframe, then it's time to close the project. The project manager will present the completed work to the client or the Company Executive Management.

No matter the nature of the project, it is crucial to follow the above sequence to ensure effective project management leveraging on all the basic steps above. This will ensure the seamless flow of its implementation and control of project activities to stay within schedule and budget. Now, let us look at the Project Cost Control as it effects Project Management:

Project Cost Control

Project cost control could be seen as one of the most important project management activities needed to ensure your project is delivered within the cost expectations laid down by the project's definition as discussed above. Almost all the projects need to be guided right throughout in order to achieve the expected management objective(s) at the end of the project. The Project Manager and his team is fully responsible for the project; most importantly the project manager needs to be able to carry out effective time and cost control to stay within budget. Project management would not be effective

at all if your project manager fails in this respect, as it would essentially determine

AMSCCE - 1101

whether or not your organization will save cost even while achieving the project objectives within the time frame. There are, however, several techniques that can be used for this purpose. They include:

Project Budget

You would need to ideally make a budget at the beginning of the planning session with regard to the project you have. It is this budget that you would have to help you for all payments that need to be made and costs that you will incur during the project life cycle. The making of this budget therefore entails a lot of research and critical thinking. Like any other budget, you would always have to leave room for adjustments as the costs may not remain the same right through the period of the project. Adhering to the project budget at all times is key to the profit from project.

Cost Tracking

Keeping track of all actual costs is also equally important as any other technique. Here, it is best to prepare a budget that is time-based. This will help you keep track of the budget of a project in each of its phases. The actual costs will have to be tracked against the periodic targets that have been set out in the budget. These targets could be on a monthly or weekly basis or even yearly if the project will go on for long.

This is much easier to work with rather than having one complete budget for the entire period of the project. If any new work is required to be carried out, you would need to make estimations for this and see if it can be accommodated with the final amount in the budget. If not, you may have to work on necessary arrangements for 'Change Requests', where the client will pay for the new work or the changes.

Time Management

Another effective technique would be effective time management. Although this technique does apply to various management areas, it is very important with regard to project cost control.

Project Change Control

Project change control is yet another crucial technique in cost control. Change control systems are essential to take into account any potential variations that could occur during the course of the project. This is due to the fact that each change to the scope of the project will have an impact on cost and the deadlines of the deliverables, so the changes may increase project cost by increasing the effort needed for the project.

Collecting Project Cost Control Data

Most organizations have some form of purchasing system for procuring goods and services in order to function as a business. Such systems are capable of tracking purchase requisitions, purchase orders, goods received/delivery notes as well as invoice payment status. Consequently both Committed and Actual Cost information can be obtained directly from these purchasing systems. Your flow of purchase orders through the system is likely to coincide with every other purchase order which your organization generates, so it's imperative that some form of reference or code is used to differentiate your project commitments from all the other commitments your organization regularly makes. It just makes collecting the data easier and more accurate. Simple with today's computerized purchasing system.

5 Explain the method Earned value Analysis. (Dec 14,18,19, May 15)

EARNED VALUE ANALYSIS

Earned value analysis is based on assigning a 'value' to each task or work package as identified in the work breakdown structure (WBS) based on the original expenditure forecasts.

The assigned value is the original budgeted cost for the item and is known as the planned value (PV) or budgeted cost of work scheduled (BCWS). A task that has not started is assigned the value zero and when it has been completed, it, and hence the project, is credited with the value of the task. The total value credited to a project at any point is known as the earned value (EV) or budgeted cost of work performed (BCWP) and this can be represented as a value or as a percentage of the PV. Where tasks have been started but are not yet complete, some consistent method of assigning an earned value must be applied. Common methods in software projects are:

- ❖ **The 0/100 Technique:** A task is assigned a value of zero until such time that it is completed when it is given a value of 100% of the budgeted value
- ❖ **The 50/50 Technique:** A task is assigned a value of 50% of its value as soon as it is started and then given a value of 100% once it is complete
- ❖ **The Milestone Technique:** A task is given a value based on the achievement of milestones that have been assigned values as part of the original budget plan

The 0/100 technique is the preferred technique. The 50/50 technique can give a false sense of security by over-valuing the reporting of activity starts. The milestone technique might be appropriate for activities with a long duration estimate

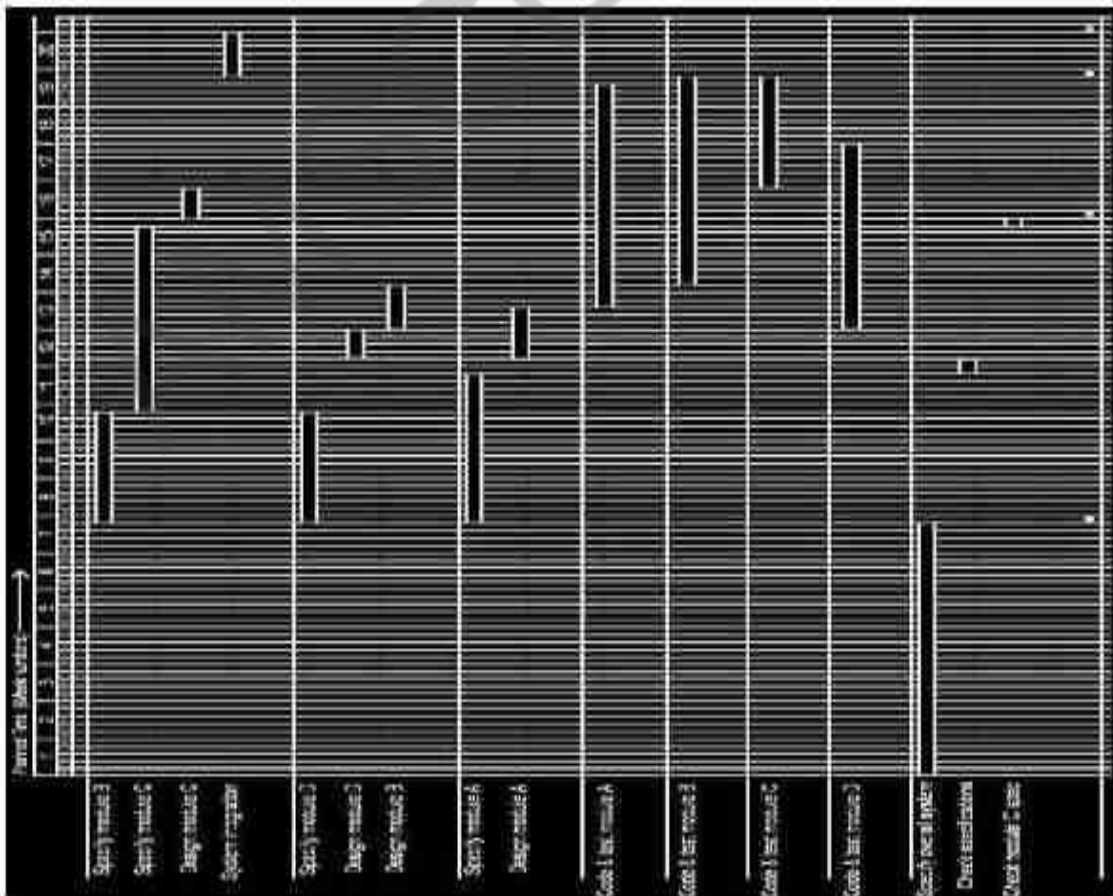

Figure 11: Work Schedule

The project is not expected to be credited with any earned value until day 34, when the activity 'specify overall system' is to be completed. This activity was forecast to consume 34 person days and it will therefore be credited with 34 person-days of earned value when it has been completed. The other steps in the baseline budget chart coincide with the scheduled completion dates of other activities.

Table 6.2: Baseline Budget Calculation

Task	Budgeted Workdays	Scheduled completion	Cumulative workdays	%Cumulative earned value
Specify overall system	34	34	34	14.35
Specify module B	15	49	64	27.00
Specify Module D	15	49		
Specify Module A	20	54	84	35.44
Check specification	2	56	86	36.28
Design module D	4	60	90	37.97
Design module A	7	63	97	40.93
Design module B	6	66	103	43.46
Check module C spec	1	70	104	43.88
Specific Module C	25	74	129	54.43
Design module C	4	79	133	56.12
Code & test module D	25	85	158	66.67
Code & test module A	30	93	188	79.32
Code & test module B	28	94	231	97.47
Code & test module C	15	94		
System integration	6	100	237	100.00

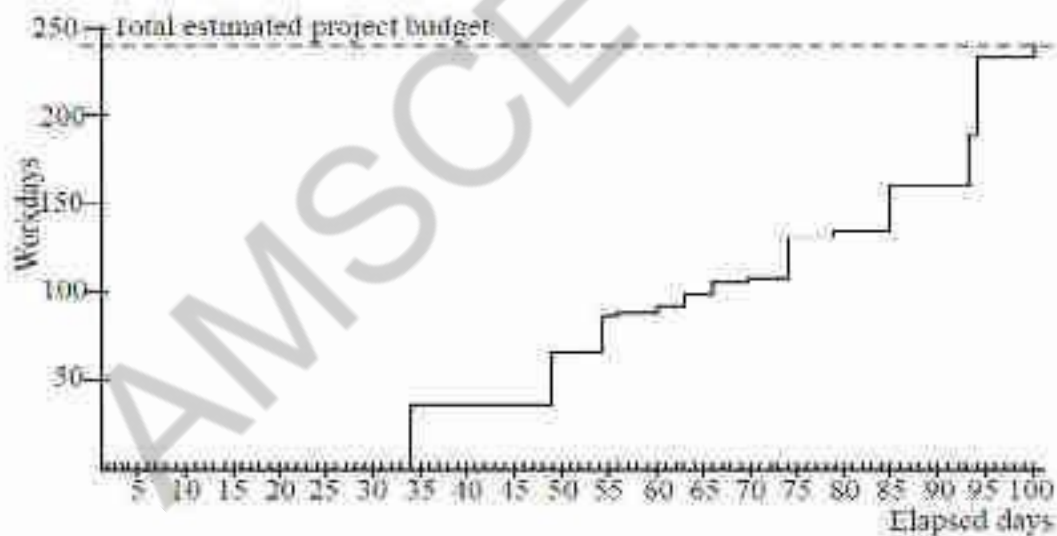

Figure 6.12: Diagrammatic Illustration of Baseline Budget

Monitoring Earned Value

Once the baseline budget has been created the next task is to monitor earned value as the project progresses. This is done by monitoring the completion of tasks or activity starts and milestone achievements. Figure 6.13 illustrates earned value analysis at the start of week 12 of the project. It can be inferred that the earned value (EV) is clearly lagging behind the baseline budget, indicating that the project is behind schedule. By analyzing Figure 6.13 can it can easily be told what has gone wrong with her project

and what the consequences might be.

AMSCCE - 1101

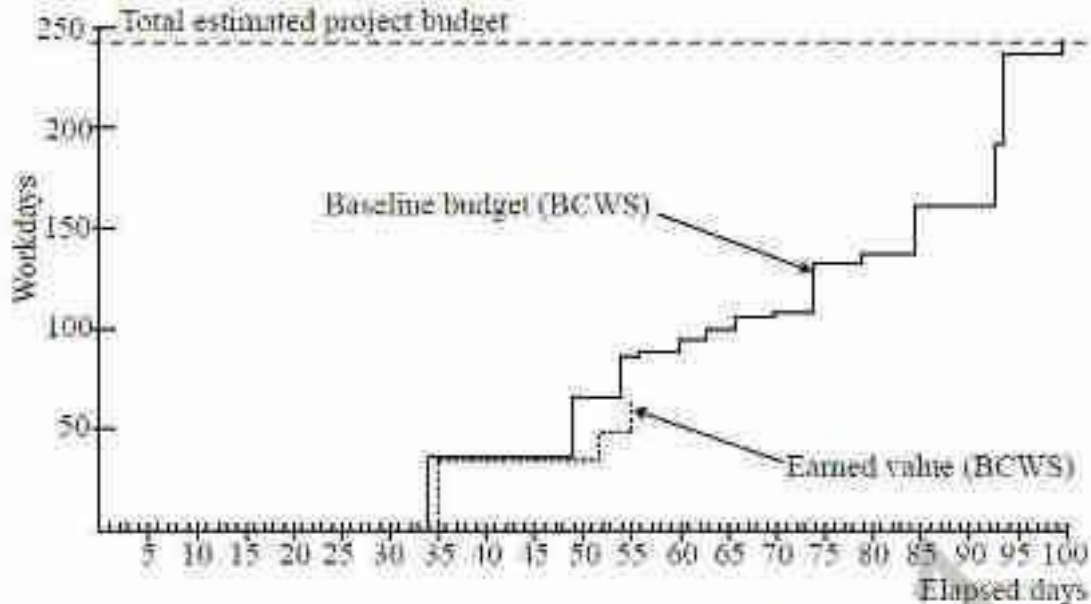

Figure 6.13: Diagrammatic Illustration of Earned Value analysis at Week 12

As well as recording EV, the actual cost of each task can be collected as actual cost (AC). This is also known as the actual cost of work performed (ACWP). The same is illustrated in Figure 6.14, which, in this case, records the values as percentages of the total budgeted cost.

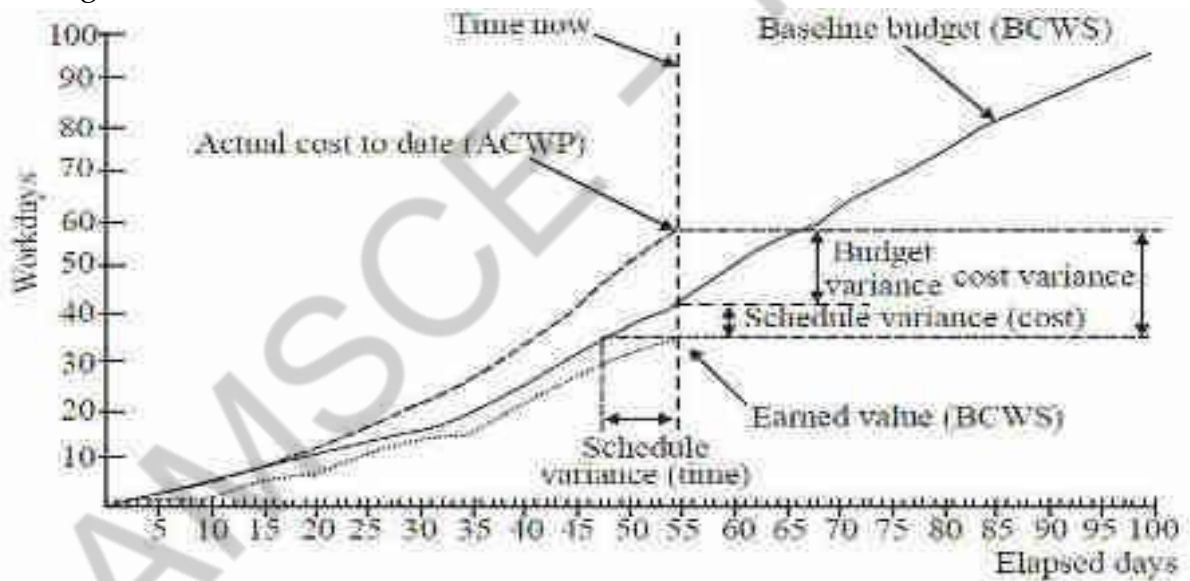

Figure 6.14: Diagrammatic Illustration of Earned Value Tracking Chart

Figure 6.14 illustrates the following performance statistics, which can be shown directly or derived from the earned value chart.

Schedule Variance

The schedule variance is measured in cost terms as $EV - PV$ and indicates the degree to which the value of completed work differs from that planned. Figure 6.14 also indicates the schedule variance in time which indicates the degree to which the project is behind schedule. A negative SV means the project is behind schedule.

Cost Variance

Cost variance as computed as $EV - AC$ and indicates the difference between the budgeted cost and the actual cost of completed work. It is also an indicator of the

accuracy of the original cost estimates. A negative CV means the project is over cost.

AMSCCE - 1101

Performance Ratios

Two ratios are commonly tracked. They are listed below:

The cost performance index (CPI = EV / AC) the schedule performance index (SPI = EV / PV). They can be thought of as a 'value for money' index.

A value greater than one indicates that work is being completed better than planned, whereas value of less than one means that work is costing more than and / or preceding more slowly than planned. CPI can be used to produce a revised cost estimate for the project or estimate at completion (EAC). EAC is calculated as BAC/CPI where budget at completion BAC is the current projected budget for the project. Figure illustrates an earned value chart with revised forecasts.

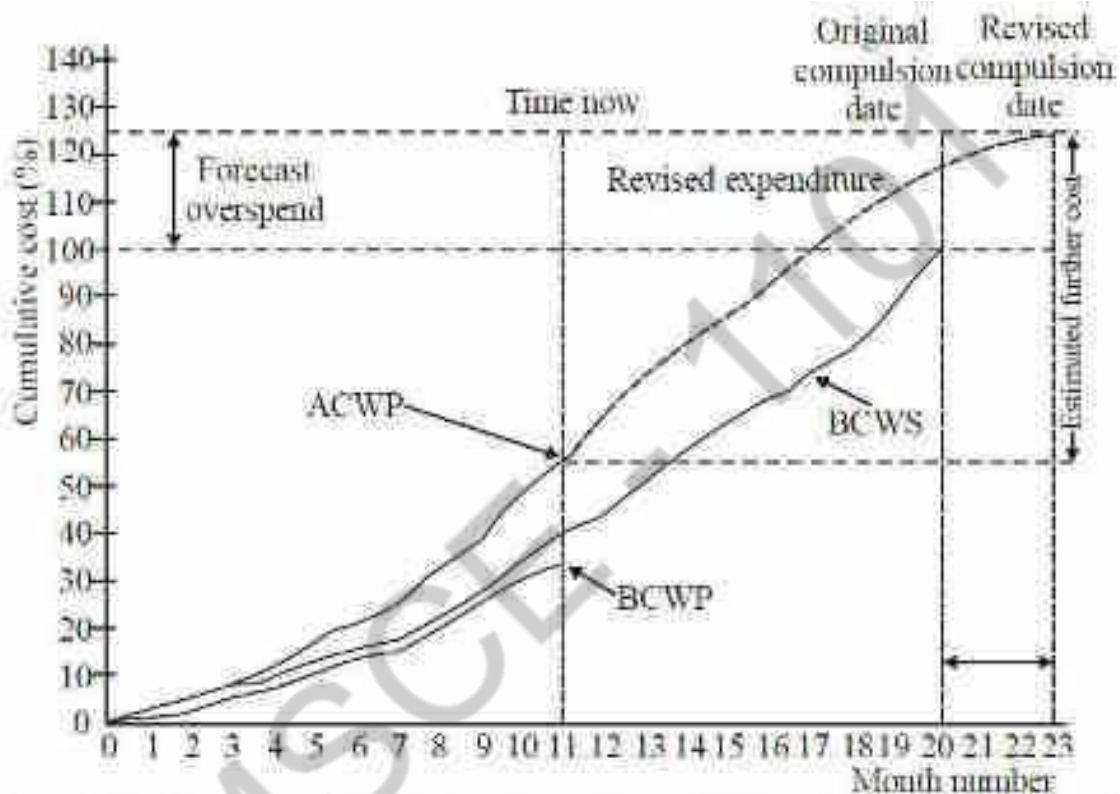

Figure 6.15: Diagrammatic Illustration of Earned Value Chart with Revised Forecasts

- Estimate at completion $EAC = BAC / CPI$ (Budget at completion)

6	<p>Discuss in detail about project termination.</p> <p>Project termination is one of the most serious decisions a project management team and its control board have to take. It causes frustration for those stakeholders who sincerely believed - and in most cases still believe - that the project could produce the results they expected, or still expect. The project manager and his or her team members, very important stakeholders of the project as well, will feel that they personally failed. They also will be scared of negative consequences for their careers; their motivation and consequently, productivity will decrease significantly.</p> <p>In contrast to that, we are convinced that conscious project termination at the right time, based on clear and well communicated criteria, profoundly discussed with the whole project management team, and finally mutually decided, is one of the boldest actions the involved or affected members of an organization can take.</p>
---	--

What can we do to avoid those negative consequences? Here, we list what we hear in our training, consulting, and coaching sessions, together with our own experiences:

- A clearly communicated strategy of the organization
- Clearly communicated reasons why and how the project supports that strategy, and under what conditions it does not
- Clearly set and communicated project success criteria (in terms of scope, schedule, and budget), if possible clearly set and communicated termination criteria
- High level management attention, even for smaller projects, and even then when everything still seems to be on track
- Periodical review meetings with the control board
- Open discussions with the control board about problems and possible solutions or alternatives, including termination
- In case the project has to be terminated, a clear commitment of the control board and high level management towards the project management team in order to enable the team to follow the project closure procedures
- Upon successful termination, similar rewards and incentives for the project manager and his or her team as with regular project closure

Reasons Why Project Termination Becomes Necessary

- Technical reasons
- Requirements or specifications of the project result are not clear or unrealistic
- Requirements or specifications change fundamentally so that the underlying contract cannot be changed accordingly
- Lack of project planning, especially risk management
- The intended result or product of the project becomes obsolete, is not any longer needed
- Adequate human resources, tools, or material are not available
- The project profit becomes significantly lower than expected, due to too high project cost or too low project revenue
- The parent organization does not longer exist
- The parent organization changes its strategy, and the project does not support the new strategy
- Force majeure (e.g. earthquake, flooding, etc.)
- Necessary conditions disappear
- Lack of management support
- Lack of customer support

Whenever along the life cycle of a project it becomes clear that we have to terminate it, there will be achievements we need to document. The least achievement is new knowledge and experience about what does not work. We need to document this so that the organization does not run into a similar situation again. Therefore, we

	<p>emphasize again that it is vital to run the regular project closure procedures for a project we have to terminate. As such, adequate project termination marks successful project management.</p>
7	<p>Explain change control.(Nov 18,19,Apr 19)</p> <p>This is the process of reviewing all change requests, approving changes and managing changes to the deliverables, project documents and the project plan. It is conducted from project initiation through completion because no matter how carefully planned a project has been, changes will need to be made throughout its life cycle. This is one of the most important areas of the project because the cost of implementing changes goes up as the project progresses. Therefore, it is best to make essential changes as soon as possible in the project.</p> <p>Any stakeholder involved with the project may request changes. For example, end-users may realize that their requirements have changed or testing of a product may show that it is inappropriate in some unforeseen way. The business may be affected by changes in legislation, changes in government policy or changes in business strategy. It is also possible that project team members may believe that an emerging technology may offer a better solution to that originally planned or that a product just might not work the way that it was supposed to.</p> <p>All of these potential changes need a process to control them and their effect on the project. This process, called change control, should ensure that proposed changes are interpreted in terms of their potential effect on project timescales, costs, benefits, quality and personnel.</p> <p>This means that although they may be initiated verbally, they should always be recorded in written form and entered into a change management system as a formal change request. As such, they will be subject to the process specified in the change control system and must be either approved or rejected.</p> <p>If a change request or document update request is raised, then an impact analysis should be performed. This process looks at the knock-on effects of the change on other products, and also the effect if the changes are not implemented. This decision is usually taken by the project manager or a change control board (CCB) responsible for approving or rejecting change requests. The purpose of the impact analysis is to arrive at a balanced view of the effect of the proposed change on the projects ability to satisfy its mandate. This will enable project management to decide whether to proceed with the change or not.</p> <p>Approved change requests can require new or revised cost estimates, activity sequences, schedule dates, resource requirements, and analysis of risk response alternatives. The applied level of change control is dependent upon the application area, complexity of the specific project, contract requirements, and the context and environment in which the project is performed.</p>



These changes will result from both external influences as well as problems that arise within the project environment. The four main sources of change are:

- 1) Environmental: resulting from changes in legislation, government policy, or business strategy.
- 2) Organizational: High-level business decisions may change the basic terms of reference of the project - for example, there may be a change to the overall scope of the project.
- 3) End-User: resulting from changes in customer requirements. It is also possible that feedback gained during the review or **testing** of a product may show that it is unsuitable in some unexpected way.
- 4) Technical: New technology may offer a better solution to that originally planned. Alternatively, technical problems may prevent a product from working in the way that it was supposed to.

All of these potential changes need a process to control them and their effect on the project. This process, called change control, should ensure that proposed changes are interpreted in terms of their potential effect on project timescales, costs, benefits, quality, and personnel.



AMSCCE - 1101

Where there is a proposed alteration to the project's products, change control should analyze the change and assess its impact, prioritize and plan the necessary work, and finally control its implementation.

Any person associated with a project should be able to raise any concern they have at any time. The concern may involve a perceived problem or a suggestion for an improvement to some area of the work, documentation, or project organization. These issues should be reviewed at regular meetings.



There are three possible outcomes when an issue is considered:

1. A change to the design or features of a product may be agreed. This will mean changing the way the product is specified in the plans and updating any costs and timescales accordingly. An impact analysis should also be performed. This process looks at the knock-on effects of the change on other deliverables, and also the effect if the changes are not implemented. The purpose of the impact analysis is to arrive at a balanced view of the effect of the proposed change on the project's ability to satisfy its mandate. This will enable the project manager to decide whether to proceed with the change or not.
2. The proposed change is rejected because it is not felt to represent a significant concern.
3. The third option is unusual but it does occasionally happen that a deliverable does not agree with its specification and changing the specification is a better solution than changing the deliverable.

Where changing the deliverable is thought to be the best option, the project manager should use the impact analysis to assess the change in terms of its effect on timescales, cost, benefit, quality, personnel, and risk and to decide at what level the decision to proceed should be taken. He or she should then determine whether or not the proposed change is significant enough to be referred back to the sponsor.

Change control meetings involve the CCB described previously. The roles and responsibilities of these boards are clearly defined and agreed upon by appropriate stakeholders and documented in the change management plan. CCB decisions are documented and communicated to the stakeholders for information and follow-up actions. These involve people who are responsible for managing the project work including the **project manager**, the **project sponsor**, selected project team members, selected **stakeholders**, anyone with responsibility for any of the project management

processes, and others as needed.

AMSCCE - 1101

	<p>Collective decision-making is very important area of project management that can make or break this part of the project. It will involve meetings between the project manager, the team and other stakeholders in order to make decisions about the activity definitions and associated estimates. How well these meetings are conducted will have a major impact on how smoothly the project runs.</p>
8	<p>Explain about software configuration management.(Nov/Dec 18,19)</p> <p>Throughout development, software consists of a collection of items (such as programs, data and documents) that can easily be changed. During software development, the design, code, and even requirements are often changed, and the changes occur at any time during the development. This easily changeable nature of software and the fact that changes often take place require that changes be done in a controlled manner.</p> <p>Software configuration management (SCM) is the discipline for systematically controlling the changes that take place during development. Software configuration management is a process independent of the development process largely because most development models cannot accommodate change at any time during development. SCM can be considered as having three major components:</p> <ul style="list-style-type: none">• Software configuration identification• Change control• Status accounting and auditing <p>Configuration identification:</p> <p>The first requirement for any change management is to have clearly agreed-on basis for change. That is, when a change is done, it should be clear to what changes has been applied. This requires baselines to be established. A baseline change is the changing of the established baseline, which is controlled by SCM.</p> <p>After baseline changes the state of the software is defined by the most recent baseline and the changes that were made. Some of the common baselines are functional or requirements baseline, design baseline, and product or system baseline. Functional or requirement baseline is generally the requirements document that specifies the functional requirements for the software. Design baseline consists of the different components in the software and their designs. Product or system baseline represents the developed system.</p> <p>It should be clear that a baseline is established only after the product is relatively stable. Though the goal of SCM is to control the establishment and changes to these baselines, treating each baseline as a single unit for the purpose of change is undesirable, as the change may be limited to a very small portion of the baseline.</p> <p>Change control:</p> <p>Most of the decisions regarding the change are generally taken by the configuration control board (CCB), which is a group of people responsible for configuration management, headed by the configuration manager. For smaller projects, the CCB might consist of just one person. A change is initiated by a change request.</p>

	<p>The reason for change can be anything. However, the most common reasons are requirement changes, changes due to bugs, platform changes, and enhancement changes. The CR for change generally consists of three parts. The first part describes the change, reason for change, the SCIs that are affected, the priority of the change, etc.</p> <p>The second part, filled by the CM, describes the decision taken by the CCB on this CR, the action the CM feels need to be done to implement this change and any other comments the CM may have. The third part is filled by the implementer, which later implements the change.</p> <p>Status accounting and auditing:</p> <p>For status accounting, the main source of information is the CRs and FRs themselves. Generally, a field in the CR/FR is added that specifies its current status. The status could be active, complete, or not scheduled. Information about dates and efforts can also be added to the CR, the information from the CRs/FRs can be used to prepare a summary, which can be used by the project manager and the CCB to track all the changes.</p>
9	<p>Discuss the steps in managing the contracts.(<i>May 13</i>)</p> <p>A contract is an agreement between two parties that creates an obligation to perform (or not perform) a particular duty.</p> <p>A legally enforceable contract requires.</p> <ul style="list-style-type: none"> ❖ Where equipment is being supplied then, in English law, this may be regarded as a contract for the supply of goods. ❖ In the case of the supply of software this may be regarded as supplying service or the granting of a license to use the software, which remains in the ownership of the supplier. <p>IS2207 approach to the acquisition and supply of software</p> <ul style="list-style-type: none"> ❖ Major process relating to software <ul style="list-style-type: none"> ✓ Acquisition ✓ supply ✓ Operation ✓ Maintenance ✓ development ❖ Acquisition process <p>It is the set of procedures that a customer for software should follow in order to obtain that software from an external source.</p> ❖ Supply process <p>It is the set of procedures that the supplier should adopt in order to satisfy the acquirer's needs.</p>
10	<p>What are the stages in contract management?(<i>Dec 11,13, Apr 19</i>)</p> <p>Stages in contract Management</p> <ul style="list-style-type: none"> ❖ Requirement analysis <ul style="list-style-type: none"> ✓ External consultant can draw up a requirements document. ✓ Check requirements reflects their needs.

- ✓ Functional requirements ,quality requirements
 - ❖ Evaluation plan
 - ✓ Check mandatory requirement
 - ✓ Consider desirable requirement
 - ✓ Calculate the cost for the whole life time of the proposed system
 - ✓ Increase in quality-increase in cost
 - ❖ Invitation to tender
 - ✓ It contains the requirement document with supporting letter which specifies how to prepare the response
 - ✓ Deadline specified
 - ❖ Evaluation of proposal
 - ✓ Scrutiny of the proposal document
 - ✓ Interviewing suppliers representatives
 - ✓ Demonstration
 - ✓ Site visit
 - ✓ Practical test
- Typical terms in contract management
- Form of agreement
 - Goods and services to be supplied
 - Environment
 - Customer commitment
 - Standards
 - Timetable
 - Price and payment methods

11

Discuss the types of contract with example. (Dec 12, May 12, 13, 15, 18, 19)

A contract is an agreement between two parties that creates an obligation to perform (or not perform) a particular duty.

Types of contract

- ❖ Fixed price contracts
- ❖ Time and materials contract
- ❖ Fixed price per delivered unit contracts

Fixed price contracts

As the name implies, in this situation a price is fixed when the contract is signed. In other words when the contract is to construct a s/w system, the detailed requirements analysis must already have been carried out.

Advantages

- ❖ If there are few subsequent changes to the original requirements, the customers will have a known outlay
- ❖ the supplier has a motivation to manage the delivery of the system in a cost-effective manner

Disadvantages

- ❖ Higher prices to allow for contingency:
- ❖ Difficulties in modifying requirements
- ❖ Upward pressure on the cost of changes

- ❖ Threat to system quality

Time and materials contracts

In type of contract, the customer is charged at a fixed rate per unit of effort.

Advantages

- ❖ Ease of changing requirements
- ❖ Changes to requirements are dealt with easily, where a project has a research orientation and the direction of the project changes as options are explored, then this can be an appropriate method of calculating payment.
- ❖ Lack of price pressure
- ❖ The lack of price pressure can allow better quality software to be produced.

Disadvantages

- ❖ Customer liability
- ❖ The customer absorbs all the risks associated with poorly defined or changing requirements.
- ❖ Lack of incentives for supplier: the supplier has no incentive to work in a cost-effective manner or to control the scope of the system to be delivered.

Fixed price per unit delivered

- ❖ This is often associated with function point (FP) counting. The size of the system to be delivered is calculated or estimated at the outset of the project.
- ❖ The size of the system to be delivered might be estimated in lines of code.
- ❖ A price per unit is also quoted.
- ❖ The final price is then the unit price multiplied by the number of unit sit delivered contracts

Advantages

- ❖ Customer understanding: the customer can see how the price is calculated and how it will vary with changed requirements
- ❖ Comparability : pricing schedules can be completed
- ❖ Emerging functionality: the supplier does not bear the risk of increasing functionality
- ❖ Supplier efficiency:- the supplier still has an incentive to deliver the required functionality in a cost-effective manner
- ❖ Life-cycle range: - the requirements do not have to be definitively specified at the outset. Thus the development contract can cover both the analysis and design stages of the project.

Disadvantages

- ❖ Difficulties with software size measurements
- ❖ Changing requirements

Another way to categorize contract

- ❖ Open
- ❖ Restricted
- ❖ Negotiated

Open tendering process

- ❖ Any supplier can bid to supply the goods and services

- ❖ Invitation to tender must be considered and evaluated in the same way as all

AMSCE - 1101

	<p>others</p> <p>Restricted tendering process</p> <ul style="list-style-type: none"> ❖ In this case , there are bids only from suppliers who have been invited by the customer ❖ Reduce the number of suppliers <p>Negotiated procedure</p> <ul style="list-style-type: none"> ❖ Single supplier might be justified
<p>UNIT V STAFFING IN SOFTWARE PROJECTS</p> <p>Managing people - Organizational behavior - Best methods of staff selection - Motivation - The Oldham-Hackman job characteristic model - Ethical and Programmed concerns - Working in teams - Decision making - Team structures - Virtual teams - Communications genres - Communication plans.</p>	
<p>PART-A</p>	
1	<p>What are the concerns in Managing People In Software Environments?</p> <ul style="list-style-type: none"> ✓ Staff Selection ✓ Staff Development ✓ Staff Motivation ✓ Well-being Staff during course of project
2	<p>What are the three basic objectives of organizational behavior? (May 14)</p> <ul style="list-style-type: none"> ✓ To select the best people for the job. ✓ To instruct them in the best methods. ✓ To give instructions in the form of higher wages to the best workers.
3	<p>How do you select the right persons for the job? (Dec 12)</p> <p>There is no perfect answer, but the interview process can be a tremendous help if you use it effectively. In order, the key steps to finding the right person to fill a position in your company include:</p> <ul style="list-style-type: none"> ✓ Determining your need to hire a new employee. ✓ Conducting a thorough job analysis. ✓ Writing a job description and job specification for the position based on the job analysis. ✓ Determining the salary for the position, based on internal and external equity. ✓ Deciding where and how to find qualified applicants. ✓ Collecting and reviewing a fair amount of applications and resumes and then selecting the most qualified candidates for further consideration. ✓ Interviewing the most qualified candidates for the position, based on the job's description and specification. ✓ Checking references and Hiring the best person for the job.

4	<p>Write the general approach might be followed in the recruitment process.</p> <ul style="list-style-type: none">✓ Create a job specification✓ Create a job holder profile✓ Obtain applicants✓ Examine CVs✓ Interviews and Other procedures.
---	--

AMSCCE - 1101

5	<p>List the various models of motivation are:</p> <ul style="list-style-type: none"> ✓ The Taylorist model ✓ Maslow's hierarchy of needs ✓ Herzberg's two-factor theory ✓ The expectancy theory of motivation
6	<p>What is Taylorist model?</p> <p>Taylor had a simple view about what motivated people at work – money. He felt that workers should get a fair day's pay for a fair day's work, and that pay should be linked to the amount produced (e.g. piece-rates). Workers who did not deliver a fair day's work would be paid less (or nothing). Workers who did more than a fair day's work (e.g. exceeded the target) would be paid more.</p>
7	<p>What is "Maslow's hierarchy of needs? (May 12,15)</p> <ul style="list-style-type: none"> ✓ Physiological Needs – attention turns to safety and security ✓ Security or Safety Needs- Calculation, Domain, Consulting, ✓ Affiliation or Social Needs – Developing New Programs ✓ Esteem Needs- needs for esteem can become dominant ✓ Self-actualization Needs – include symmetry
8	<p>State Herzberg's two factor theory. (Dec 14)</p> <p>Job satisfaction by Herzberg and his associates found two sets of factors about a job</p> <ul style="list-style-type: none"> ✓ Hygiene or maintenance factors – which can make you dissatisfied if they are not right for example the level of pay or the working conditions ✓ Motivators – which make you, feel that the job is worthwhile, like a sense of achievement or the challenge of the work itself.
9	<p>What is expectancy theory of motivation?</p> <p>It identifies three influences on motivation</p> <ul style="list-style-type: none"> ✓ Expectancy: the belief that working harder will lead to a better performances ✓ Instrumentality: the belief that better performance will be rewarded ✓ Valence: of the resulting reward
10	<p>What are the factors to be considered in the Oldham-Hackman job characteristic model?</p> <ul style="list-style-type: none"> ✓ Skill variety- one or more of the offerings available from a variety of organizations ✓ Task variety- enhance Key words ✓ Task significance- autonomy, and feedback from the job ✓ Autonomy- for Consulting & Software Companies ✓ Feedback- submit your comments and suggestions
11	<p>Mention the methods of improving motivation.</p> <p>To improve motivation the manager might do the following</p> <ul style="list-style-type: none"> ✓ Set specific goals ✓ Provide feedback ✓ Consider job design.

12	What are the measures used to enhance job design? <ul style="list-style-type: none">✓ Job Enlargement✓ Job Enrichment
----	---

AMSCCE - 1101

13	<p>Define Job Enlargement.</p> <p>Job enlargement expands job horizontally. It increases job scope; that is, it increases the number of different operations required in a job and the frequency with which the job cycle is repeated. By increasing the number of tasks an individual performs, job Enlargement, increases the job scope, or job diversity.</p>
14	<p>Define Job Enrichment.</p> <p>The job holder carries out that are normally done at a managerial or supervisory level. With programmers in a maintenance team they might be given authority to accept requests for changes that involve then five day's work without the need for their manager's approval.</p>
15	<p>What are the measures to reduce the disadvantages of group decision making?</p> <ul style="list-style-type: none"> ✓ The cooperation of a number of experts. ✓ The problem is presented to the experts. ✓ The experts record their recommendations. ✓ These recommendations are collated and reproduced. ✓ The collect responses are recirculated.
16	<p>What are the various stages of development of a team?</p> <ul style="list-style-type: none"> ✓ Forming: The members are the group get to know each other and try to set up some ground rules about behavior. ✓ Storming: Conflicts arise as various members of the group try to exert leadership and the group's methods of operation are being established ✓ Norming: conflicts are largely settled and feeling of group identity emerges ✓ Performing: The emphasis is now on the tasks at hand. ✓ Adjourning: the group disbands ✓ Storming: The Second Stage of Group Development.
17	<p>Define team worker.</p> <p>Skilled at creating a good working environment to manage all the people who are developing Projects, team proposed to extend these concepts.</p>
18	<p>What are the two categorized for decision making?</p> <ul style="list-style-type: none"> ✓ Structured- generally relatively simple, routine Decisions where rules can be applied in a fairly straightforward way ✓ Unstructured- more complex and often requiring a degree of creativity.
19	<p>Mention some mental obstacles to good decision making. (May 13)</p> <ul style="list-style-type: none"> ✓ Faulty heuristics- is an innovative effort by students and members of staff ✓ Escalation of commitment-119 behavior, sunk cost, risk propensity, risk perception, ✓ Information overhead- developers analyze, design, and develop software.

20	Define team structure/Define Formal Structure.(Apr 19,Dec 19) Team structure denotes the reporting, responsibility and communication structures in individual project teams. There are mainly three formal team structures: <ul style="list-style-type: none">✓ Chief programmer,✓ Democratic, and✓ The mixed control team organizations
----	--

AMSCCE - 1101

21	<p>Define Chief Programmer Team.</p> <ul style="list-style-type: none"> ✓ In this team organization, a senior engineer provides the technical leadership and is designated as the chief programmer. ✓ The chief programmer partitions the task into small activities and assigns them to the team members. He also verifies and integrates the products developed by different team members.
22	<p>Define Democratic Team.</p> <ul style="list-style-type: none"> ✓ The democratic team structure, as the name implies, does not enforce any formal team hierarchy. Decisions are taken based on discussions, where any member is free to discuss with any other matters. ✓ Typically, a manager provides the administrative leadership. At different times, different members of the group provide technical leadership.
23	<p>Define the mixed control team organizations.</p> <p>The mixed team organization, as the name implies, draws upon the ideas from both the democratic organization and the chief-programmer organization. This team organization incorporates both hierarchical reporting and democratic set up. The democratic arrangement at the senior engineer’s level is used to decompose the problem into small parts. Each democratic setup at the programmer level attempts solution to a single part. Thus, this team organization is eminently suited to handle large and complex programs. This team structure is extremely popular and is being used in many software development companies.</p>
24	<p>What do you understand by virtual teams? (Dec 14,18, Apr 18)</p> <p>A virtual team (also known as a geographically dispersed team, distributed team, or remote team) is a group of individuals who work across time, space and organizational boundaries with links strengthened by webs of communication technology.</p>
25	<p>Draw the chief programmer team structure.</p> <div style="text-align: center;"> <pre> graph TD CP((Chief programmer)) --- L((Librarian)) CP --- P((Programmers)) CP --- S((Specialists)) </pre> </div>

26	<p>Draw the mixed control team structure.</p> <p style="text-align: center;">P r o j e c t m a n a g e r</p> <p style="text-align: center;">S e n i o r e n g i n e e r s _____</p> <p style="text-align: center;">J u n i o r e n g i n e e r s</p> <p style="text-align: center;">(28)</p> <p style="text-align: center;">Management structure</p>
	<p style="text-align: center;">(b)</p> <p style="text-align: center;">Communication path</p>

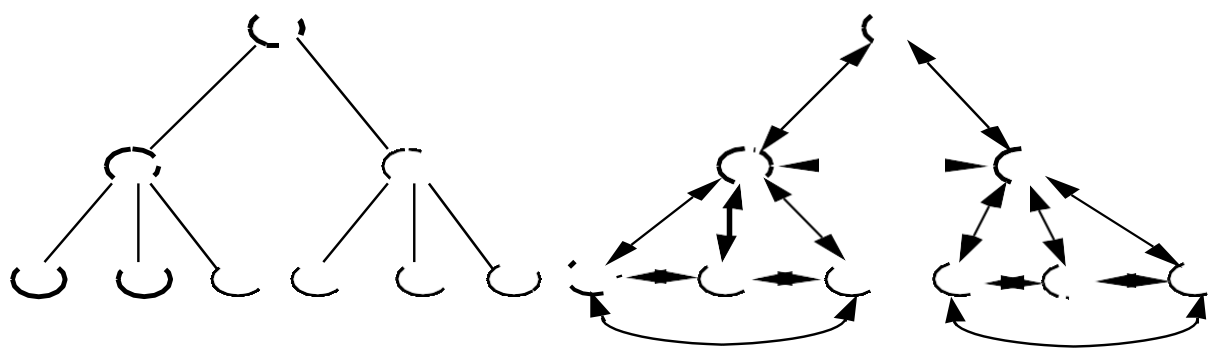

27	<p>What is a communication genre?</p> <p>Communication genres refer to methods of communication. This goes beyond technologies used and includes the organizational conventions involved in the communication. It can be selected and developed to deal with particular need for project coordination.</p>
28	<p>What is the role of ethics in project management? (Apr 18, Dec 18,19)</p> <p>Honesty, responsibility, respect and fairness are the values that drive ethical conduct for the project management profession. A code of ethics is to ensure decisions and actions are always honorable and in the best interest of stakeholders.</p>
29	<p>Write the uses of formal structure (Apr 19)</p> <ul style="list-style-type: none"> • The formal organisation structure concentrates on the jobs to be performed. It, therefore, makes everybody responsible for a given task. • A formal organisation is bound by rules, regulations and procedures. It thus ensures law and order in the organisation. • The organisation structure enables the people of the organisation to work together for accomplishing the common objectives of the enterprise.
30	<p>Define terms Storming and Forming. (Apr 19)</p> <p>Forming:</p> <p>The initial stage is the forming stage. At this point, team members are generally concerned about their role in the team and who calls the shots. As a project manager, you will have a dominant role in team building and people will be looking to you for guidance and reassurance. This stage can be relatively short in comparison to the other stages and may only last a meeting or two.</p> <p>Storming:</p> <p>At this stage, the team addresses the problems they are going to solve and how they are going to function as a unit. Team members will become more open with each other as they express their own ideas and thoughts and will often confront the project manager about certain aspects of the project.</p>
PART-B	

1	<p>Discuss the organizational behavior with example. (Dec 2012)</p> <ul style="list-style-type: none">• The management's action of motivating human beings in the organization, according to Douglas McGregor, involves certain assumptions, generalizations and hypotheses relating to human behavior and human nature• McGregor has characterized these assumptions in two opposite views, termed Theory X and Theory Y. <p>Theory X</p> <p>This is the traditional theory of human behavior, In this theory, McGregor has certain assumptions about human behavior. These assumptions are as follows</p> <ol style="list-style-type: none">1. Management is a process of directing employees' efforts, motivating them, controlling their actions, modifying their behavior to fit the needs of the organization.2. Without this active intervention by management, people would be passive – even resistant – to organizational needs. They must be persuaded, rewarded, punished, controlled, and their activities must be directed.3. The average man is by nature indolent – he works as little as possible.4. He lacks ambition, dislikes responsibility, prefers to be led.5. He is inherently self-centered, indifferent to organizational needs.6. He is, by nature, resistant to change.7. He is gullible, not very bright, the ready dupe of the charlatan and the demagogue. <p>These assumptions about human nature are negative in their approach, however much organizational processes have developed on these assumptions.</p> <p>Theory Y</p> <p>The assumptions of Theory Y are described by McGregor in the following words:</p> <ol style="list-style-type: none">1. The expenditure of physical and mental effort in work is as natural as play or rest. The average human being does not inherently dislike work. Depending upon controllable conditions, work may be a source of satisfaction or a source of punishment.2. External control and the threat of punishment are not the only means for bringing about effort towards organizational objectives. Man will exercise self-direction and self-control in the service of objectives to which he is committed.3. Commitment to objectives is a function of the reward associated with their achievement. The most significant of such awards, e.g. the satisfaction of ego and self-actualization needs, can be a direct product of effort directed towards organizational objectives.4. The average human being learns under proper conditions not only to accept, but to seek responsibility. Avoidance of responsibility, lack of ambition, and emphasis on security are generally consequences of experience, not inherent human characteristics.5. The capacity to exercise a relatively high degree of imagination, ingenuity, and
---	--

creativity in the solution of organizational problems is widely, not narrowly, distributed in the population.

The assumptions of Theory Y suggest a new approach in management. It emphasises on the cooperative endeavour of management and employees.

AMSCCE - 1101

2 Explain the recruitment process (or) Describe the recruitment process for choosing the right person for a job (or) Explain how new staff can be selected and induced into a project/do staff selection relate to quality of product? Justify with appropriate answer. (May 13,14,19,Dec 18)

THE RECRUITMENT PROCESS

It must be stressed that often project leader have little choice about the people who will make up their team.

A GENERAL APPROACH

- ❖ Create a job specification: advice is often needed as there could be legal implications in an official document.
- ❖ Create a job holder profile: it is used to construct a profile of the person needed to carry out the job.
- ❖ Obtain applicants: an advertisement would be placed, either within the organization in the trade.
- ❖ By giving the salary, location, job scope and any essential qualification, the applicants will be limited to the more realistic candidates.

Examine cvs: these should be read carefully and compared to the job holder profile- nothing is more annoying for all concerned than when people have cvs which indicate clearly that they are not eligible for the job and yet are called for interview.

Selection techniques are aptitude, personality test and the examination of sample of previous work. Any method must test specific qualities detailed in the job holder profile .interviews are the most commonly used method. An interview might be of a technical nature where the practical expertise of the candidate is assessed.

Other procedures: references will need to be taken up where necessary and a medical examination might be needed.

Steps:

Initial Contact from the Client - Based on the requirement, we assign the right recruitment consultant from day one that runs with the job until completion.

1. **Job Specification** - First steps are all about information gathering and ensuring we receive a detailed job specification - if there is no job description available your recruitment consultant will work with you to understand the role profile and selection criteria.
2. **Detailed brief** - Arras then understands the finer details of a job - the key drivers, ways of working and organizational ethos, the personality and softer skills needed for the job. All these details are shared with the candidate at shortlist stage to give them a fuller picture of the job.
3. **Timescales and Process** - By outlining the recruitment timescales and preferred interview process with you; 1st, 2nd, 3rd interviews or assessment Centre, we can plan and manage expectations throughout the process with the shortlisted candidates. We aim to try and avoid those recruitment frustrations like waiting

ages for feedback and interview short listing.

AMSCCE - 1101

4. **Search and selection** – The term used is essentially the activities we perform to find the ideal candidates for the job. We encourage candidates to register with us - this is where most of our placed project management candidates originate from. The next step is to advertise on the project management job board. We then use a selection of methods both online (job boards, social media etc.) and offline (networking groups, press etc).
5. **Arras One-to-One interview** – There is an initial screening project management interview with the recruitment consultant for each candidate for each role we recruit for. We have never shortlisted a candidate for a client without carrying out this interview - this works for both parties; we understand more about a candidates skills, experiences and suitability for the job whilst informing about the company and the opportunity they are being interviewed for.
6. **Short listing** – Following the project management interview candidates are asked if the role is something that they would like to pursue. Arras People only forward details of candidates to our clients when given expressed permission to do so. When in agreement, the consultant will send the candidate CV and an **individual profile** of skills, experience and capability for the job.
7. **Interview management** – Once the client has reviewed the CV and profile candidates are notified when feedback is available. If a candidate is unsuccessful at this stage, the consultant will give feedback. Feedback obviously comes back in varying degrees of detail but we share everything we know. All candidates selected to attend an interview will be contacted by the consultant straight away with the details. With each interview, the consultant will arrange for an **interview preparation session**, helping candidates get ready for the interview by sharing details about the type of interview, who will be interviewing and any hints and tips which will be useful for that particular job and client. Interview preparation sessions are carried out for each interview - regardless of how many stages. If interviews include a presentation - the consultant will walk through and review that.
8. **Offers** – Each consultant at Arras is here to represent candidates through to the offer and negotiation stage. Following the successful interview candidates are contacted with feedback and the pending offer. By working closely with the Arras consultant, candidates can be assured that the offer stage is managed effectively and smoothly to completion.
9. **Start** – When details of offers and start dates are finalized, the Arras consultant remains in touch throughout. Arras will follow up with brief calls to make sure you are happy in your new job.

3	<p>Discuss about the different models of Motivation. (May 19,15,14,13,Dec 14)</p> <p>The various models of motivation are:</p> <ul style="list-style-type: none">❖ The Taylorist model❖ Maslow’s hierarchy of needs❖ Herzberg’s two-factor theory❖ The expectancy theory of motivation
---	---

AMSCCE - 1101

The Taylorist model:

Taylor had a simple view about what motivated people at work - money. He felt that workers should get a fair day's pay for a fair day's work, and that pay should be linked to the amount produced (e.g. piece-rates). Workers who did not deliver a fair day's work would be paid less (or nothing). Workers who did more than a fair day's work (e.g. exceeded the target) would be paid more.

The implications of Taylor's theory for managing behavior at work were:

- ❖ The main form of motivation is high wages, linked to output
- ❖ A manager's job is to tell employees what to do
- ❖ A worker's job is to do what they are told and get paid accordingly

Weaknesses in Taylor's Approach:

- ❖ The most obvious weakness in Taylor's approach is that it ignores the many differences between people. There is no guarantee that a "best way" will suit everyone.
- ❖ Secondly, whilst money is an important motivation at work for many people, it isn't for everyone. Taylor overlooked the fact that people work for reasons other than financial reward.

Maslow's hierarchy of needs

The basic human needs placed by Maslow in an ascending order of importance are:

1. **Physiological Needs** These are the basic needs for sustaining human life itself, such as food, water, warmth, shelter, and sleep. Maslow felt that until these needs are satisfied to the degree necessary to maintain life, other needs will not motivate people.
2. **Security or Safety Needs** These are the needs to be free of physical danger and of the fear of losing a job property, food, or shelter.

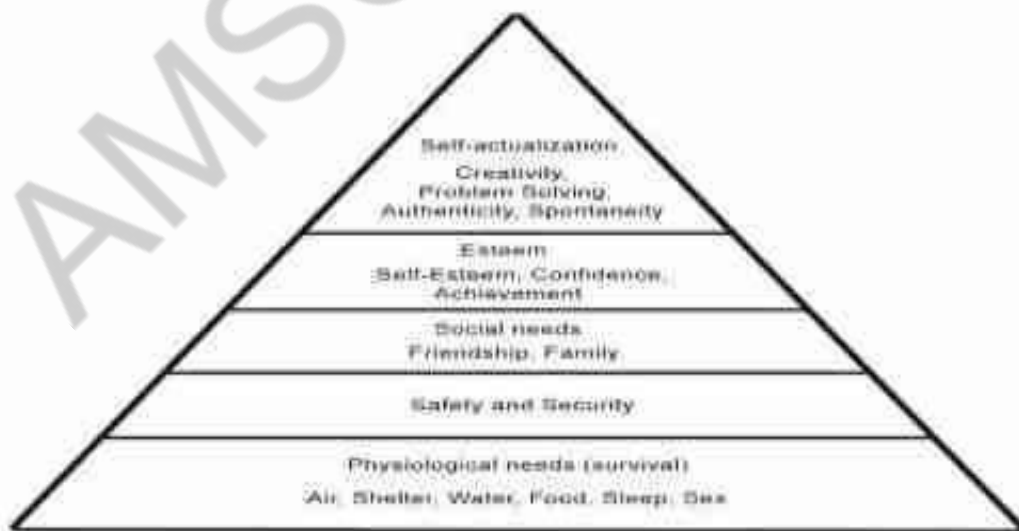

3. **Affiliation or Social Needs** Since people are social beings; they need to belong, to be accepted by others. It includes friendship, the need to love and be loved, socializing, etc.

4. Esteem Needs Once people begin to satisfy their need to belong; they tend to want to

AMSCCE - 1101

be held in esteem both by themselves and by others. This kind of need produces such satisfactions as respect, power, prestige, status, and self-confidence.

5. Self-actualization Needs This as the highest need in the hierarchy. It is the desire to become what one is capable of becoming—to fully realizes one's potential and to accomplish what one is capable of achieving.

Herzberg’s two-factor theory:

Job satisfaction by Herzberg and his associates found two sets of factors about a job:

- **Hygiene or maintenance factors**, which can make you dissatisfied if they are not right for example the level of pay or the working conditions
- **Motivators**, which make you, feel that the job is worthwhile, like a sense of achievement or the challenge of the work itself.



The expectancy theory of motivation



It identifies three influences on motivation

- Expectancy: the belief that working harder will lead to a better performances
- Instrumentality: the belief that better performance will be rewarded

- Valence: of the resulting reward.

AMSCCE - 1101

4	<p>Explain the expectancy theory of motivation.</p> <p>Expectancy theory proposes that an individual will decide to behave or act in a certain way because they are motivated to select a specific behavior over other behaviors due to what they expect the result of that selected behavior will be.</p> <p>The Expectancy Theory of Motivation explains the behavioral process of why individuals choose one behavioral option over another. It also explains how they make decisions to achieve the end they value. Vroom introduces three variables within the expectancy theory which are valence (V), expectancy (E) and instrumentality (I). The three elements are important behind choosing one element over another because they are clearly defined: effort-performance expectancy (E>P expectancy), performance-outcome expectancy (P>O expectancy).</p> <p>Three components of Expectancy theory: Expectancy, Instrumentality, and Valence</p> <ol style="list-style-type: none">1. Expectancy: Effort → Performance (E→P)2. Instrumentality: Performance → Outcome (P→O)3. Valence: V(R) <p>Expectancy: Effort → Performance (E→P)</p> <p>Expectancy is the belief that one's effort (E) will result in attainment of desired performance (P) goals.</p> <ol style="list-style-type: none">1. Self-efficacy- the person's belief about their ability to successfully perform a particular behavior. The individual will assess whether they have the required skills or knowledge desired to achieve their goals.2. Goal difficulty- when goals are set too high or performance expectations that are made too difficult. This will most likely lead to low expectancy. This occurs when the individual believes that their desired results are unattainable.3. Perceived control - Individuals must believe that some degree of control over the expected outcome. When individuals perceive that the outcome is beyond their ability to influence, expectancy, and thus motivation, is low. <p>Instrumentality: Performance → Outcome (P→O)</p> <p>Instrumentality is the belief that a person will receive a reward if the performance expectation is met. This reward may present itself in the form of a pay increase, promotion, recognition or sense of accomplishment. Instrumentality is low when the reward is the same for all performances given.</p> <p>Factors associated with the individual's instrumentality for outcomes are trust, control and policies.</p> <p>Valence V(R)</p> <p>The value an individual places on the rewards of an outcome, which is based on their needs, goals, values and Sources of Motivation. Influential factors include one's values, needs, goals, preferences and sources that strengthen their motivation for a particular outcome. Valence is characterized by the extent to which a person values a given outcome or reward. This is not an actual level of satisfaction rather the expected satisfaction of a particular outcome.</p> <p>The valence refers to the value the individual personally places on the rewards.</p>
---	--

-1 → 0 → +1

AMSCE - 1101

-1= avoiding the outcome 0 = indifferent to the outcome +1 = welcomes the outcome

In order for the valence to be positive, the person must prefer attaining the outcome to not attaining it.

Motivational Force (MF) = Expectancy x Instrumentality x Valence

When deciding among behavioral options, individuals select the option with the greatest amount of motivational force (MF).

Expectancy and instrumentality are attitudes (cognitions), whereas valence is rooted in an individual's value system. Examples of valued outcomes in the workplace include, pay increases and bonuses, promotions, time off, new assignments, recognition, etc. If management can effectively determine what their employee values, this will allow the manager to motivate employees in order to get the highest result and effectiveness out of the workplace.

5 Explain the Oldham-Hackman job characteristics model in detail. (May 12,15,Dec 14,19,Apr 18)

The job characteristics model, designed by Hackman and Oldham, is based on the idea that the task itself is key to employee motivation. Specifically, a boring and monotonous job stifles motivation to perform well, whereas a challenging job enhances motivation. Variety, autonomy and decision authority are three ways of adding challenge to a job. Job enrichment and job rotation are the two ways of adding variety and challenge.

It states that there are five core job characteristics (skill variety, task identity, task significance, autonomy, and feedback) which impact three critical psychological states (experienced meaningfulness, experienced responsibility for outcomes, and knowledge of the actual results), in turn influencing work outcomes (job satisfaction, absenteeism, work motivation, etc.). The five core job characteristics can be combined to form a motivating potential score (MPS) for a job, which can be used as an index of how likely a job is to affect an employee's attitudes and behaviors.

Hackman and Oldham's job characteristics theory proposes that high motivation is related to experiencing three psychological states whilst working:

Meaningfulness of work: That labor has meaning to you, something that you can relate to, and does not occur just as a set of movements to be repeated. This is fundamental to intrinsic motivation, i.e. that work is motivating of itself (as opposed to motivating only as a means to an end).

Responsibility: That you have been given the opportunity to be a success or failure at your job because sufficient freedom of action has given you. This would include the ability to make changes and incorporate the learning you gain whilst doing the job.

Knowledge of outcomes: This is important for two reasons. Firstly to provide the person knowledge on how successful their work has been which in turn enables them to learn from mistakes. The second is to connect them emotionally to the customer of their outputs, thus giving further purpose to the work (e.g. I may only work on a production line, but I know that the food rations I produce are used to help people in disaster areas, saving many lives).

Oldham and Hackman suggest that the satisfaction that the job gives is based on 5 factors. They are

	❖ Skill variety: - the number of different skills that the job holder has the
--	---

AMSCCE - 1101

opportunity to exercise.

- ❖ Task identity: - the degree to which your work and its results are identifiable as belonging to you.
- ❖ Task significance: - the degree to which your job has an influence on others
- ❖ Autonomy: - the discretion you have about the way you to the job.
- ❖ Feedback: - the information you get back about results of your work.



Methods of improving motivation

- Set specific goal: These goals need to be demanding and yet acceptable to staff. Involving staff in the setting goal helps to gain acceptance for them
- Provide feedback :Not only do goals have to be set but staff need regular feedback about how they are progressing
- Consider job design: Jobs can be altered to make them more interesting and give staff more feeling of responsibility.

Various measurements of job design:

Simplification of Job:

In job simplification jobs are broken in to very small parts as in assembly line operations and work can be done by same individual repeatedly and it will increase productivity and proficiency of individual.

Job Enlargement:

Job enlargement expands job horizontally. It increases job scope; that is, it increases the number of different operations required in a job and the frequency with which the job cycle is repeated. By increasing the number of tasks an individual performs, job enlargement, increases the job scope, or job diversity.

Job Rotation:

Job rotation is the systematic and planned rotation of individuals in pre-determined jobs (other than their own) so they can gain additional knowledge or skills. It is done quite a bit for developing managers (because they need to be familiar with operations overall) and also used with others who want to advance to a new role or become more knowledgeable in their current job role.

Job Enrichment:

The job holder carries out that are normally done at a managerial or supervisory level. With programmers in a maintenance team they may given authority to accept requests for changes that involve then five day’s work without the need for their manager’s approval. It is different from job enlargement (which focuses on increasing the number

of tasks a job holder is responsible for performing more work /tasks to do).

AMSCCE - 1101

6	<p>Explain in detail the term decision making in the process of managing people and organizing teams. (Dec 12,18, May 13,14)</p> <p>Decisions can be categorized as being,</p> <ul style="list-style-type: none">❖ Structured: simple, routine decisions where rules can be applied in a fairly way.❖ Unstructured: more complex and often requiring a degree of creativity. <p>Some mental obstacles to good decisions making:</p> <ul style="list-style-type: none">❖ Faulty heuristics: it can be useful but there are dangers.❖ They are based on information, stereotypes.❖ Escalation of commitment❖ Information overloaded <p>Group decision making:</p> <p>With a project team different specialists and points of view can be brought together. Decisions made by the team as a whole are more likely to be accepted than those that are imposed. Assuming that the meetings are genuinely collectively responsible and have been properly briefed, research would seem to show that groups are better at solving complex problems when the members of the group have complementary skills and expertise. The meeting allows them to communicate freely and to get ideas accepted. Groups deal less effectively with poorly structured problems needing creative solutions. Brainstorming techniques can help groups in this situation but research shows that people often come up with more ideas individually than in a group. Where the aim is to get the involvement of end users of a computer system, then prototyping and participatory approaches such as Joint Application Development might be adopted.</p> <p>Obstacles to good group decision making:</p> <p>It is time consuming</p> <ul style="list-style-type: none">❖ It can stir up conflicts within the group❖ Decisions can be unduly influenced by dominant personalities <p>Conflict can, in fact, be less than might be expected. People will modify their personal judgments to conform to group norms, common attitudes developed by a group over time. In fact, people in groups sometimes make decisions that carry more risk than where they make the decision on their own. This is known as the risky shift.</p> <p>Measures to Reduce the Disadvantages of Group Decision Making:</p> <p>One method of making group decision making more efficient and effective is by training members to follow a set procedure. The Delphi technique endeavors to collate the judgments of a number of experts without actually bringing them face to face. Given a problem, the following procedure is carried out:</p> <p>The cooperation of a number of experts is enlisted</p> <ul style="list-style-type: none">❖ The problem is presented to the experts❖ The experts record their recommendations❖ These recommendations are collated and reproduced❖ The collected responses are re-circulated❖ The experts comment on the ideas of others and modify their recommendations if so moved. If the leader detects a consensus then the process is stopped, otherwise
---	---

the comments are re-circulated to the experts.

AMSCCE - 1101

7	<p>Write a short note on ethical and professional concerns / How to deal with ethical and programming concerns in software project management. (Apr 18)</p> <p>Ethics relates to the moral obligation to respect the rights and interests of others – goes beyond strictly legal responsibilities</p> <p>Three groups of responsibilities:</p> <ul style="list-style-type: none">√ Responsibilities that everyone has√ Responsibilities that people in organizations have√ Responsibilities relating to your profession or calling <p>Organizational ethics</p> <p>There are some who argue that ethical organizational ethics are limited:</p> <ul style="list-style-type: none">√ Stockholder theory (e.g. Milton Friedman). An employee's duty is to the owners of the business (which often means the stakeholders) above all others – although legal requirements must be met.√ Competitive relationships between businesses.√ Competition may cause you to do things that could have a negative impact on the owners or employees of competitive businesses <p>Uniform Treatment</p> <p>One example of organizational ethics is the uniform treatment of all employees. Small business owners should treat all employees with the same respect, regardless of their race, religion, cultures or lifestyles. Everyone should also have equal chances for promotions. One way to promote uniform treatment in organizations is through sensitivity training. Some companies hold one-day seminars on various discrimination issues. They then invite outside experts in to discuss these topics. Similarly, small company managers must also avoid favoring one employee over others. This practice may also lead to lawsuits from disgruntled employees. It is also counterproductive.</p> <p>Social Responsibility</p> <p>Small companies also have an obligation to protect the community. For example, the owner of a small chemical company needs to communicate certain dangers to the community when explosions or other disasters occur. The owner must also maintain certain safety standards for protecting nearby residents from leaks that affect the water or air quality. There are state and federal laws that protect people from unethical environmental practices. Business owners who violate these laws may face stiff penalties. They may also be shut down.</p> <p>Financial Ethics</p> <p>Business owners must run clean operations with respect to finances, investing and expanding their companies. For example, organizations must not bribe state legislators for tax credits or special privileges. Insider trading is also prohibited. Insider trading is when managers or executives illegally apprise investors or outside parties of privileged information affecting publicly traded stocks, according to the Securities and Exchange Commission. The information helps some investors achieve greater returns on their investments at the expense of others. Executives in small companies must strive to help all shareholders earn better returns on their money. They must also avoid collusive arrangements with other companies to deliberately harm other competitors.</p>
---	---

Considerations

AMSCCE - 1101

A small company's organizational ethics can also include taking care of employees

AMSCCE - 1101

	<p>with mental illnesses or substance abuse problems, such as drug and alcohol dependency. Ethical business owners help their employees overcome these types of problems when possible. They often put them through employee advisor programs, which involves getting them the treatment they need. Employees may have issues that lead to these types of problems. Therefore, they deserve a chance to explain their situations and get the help they need.</p> <p>Professional ethics</p> <p>Professionals have knowledge about the technical domain that the general public does not. Ethical duty of the expert to warn lay people of the risks involved in a particular course of action. Many professions, or would be professions, have codes of conduct for their members.</p>
<p>8</p>	<p>Explain in detail about team structure.</p> <p>Team structures</p> <p>Team structure addresses the issue of organization of the individual project teams. There are mainly three formal team structures:</p> <ul style="list-style-type: none"> ❖ Chief programmer, ❖ Democratic, and ❖ The mixed control team organizations <p>Chief Programmer Team</p> <div style="text-align: center; margin: 20px 0;"> <pre> graph TD CP[Chief programmer] --- Librarian CP --- Programmers CP --- Specialists </pre> </div> <ul style="list-style-type: none"> ❖ In this team organization, a senior engineer provides the technical leadership and is designated as the chief programmer. ❖ The chief programmer partitions the task into small activities and assigns them to the team members. ❖ He also verifies and integrates the products developed by different team members. <p>Advantage</p> <ul style="list-style-type: none"> ❖ The chief programmer provides an authority, and this structure is arguably more efficient than the democratic team for well-understood problems. <p>Disadvantage</p> <ul style="list-style-type: none"> ❖ However, the chief programmer team leads to lower team morale, since team-members work under the constant supervision of the chief programmer. ❖ This also inhibits collective and their original thinking. ❖ The chief programmer team is subject to single point failure since too much responsibility and authority is assigned to the chief programmer. ❖ Since the chief programmer carries out many tasks individually, there is a danger of information overload on the chief programmer

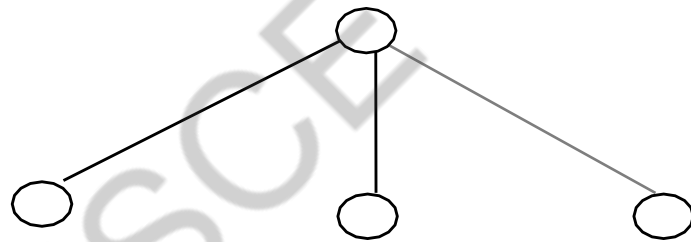

AMSCCE - 1101

Democratic Team

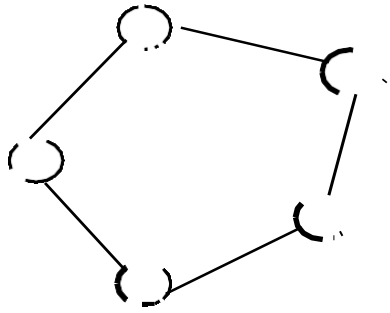

(a)

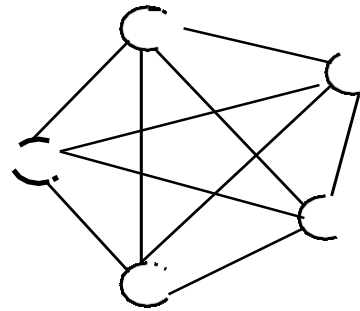

(b)

Management structure

- ❖ The democratic team structure, as the name implies, does not enforce any formal team hierarchy. Decisions are taken based on discussions, where any member is free to discuss with any other matters.
- ❖ Typically, a manager provides the administrative leadership. At different times, different members of the group provide technical leadership.

Advantages:

- ❖ The democratic organization leads to higher morale and job satisfaction.
- ❖ Democratic team structure is appropriate for less understood problems, since a group of engineers can invent better solutions than a single individual as in a chief programmer team.
- ❖ A democratic team structure is suitable for projects requiring less than five or six engineers and for research-oriented projects. For large sized projects, a pure democratic organization tends to become chaotic.
- ❖ The democratic team organization encourages egoless programming as programmers can share and review one another's work.

Disadvantages:

- ❖ Consequently, it suffers from less man-power turnover

The mixed control team organizations

Project manager

Senior engineers

Junior engineers

(a)

(b)

Management structure

Communication path

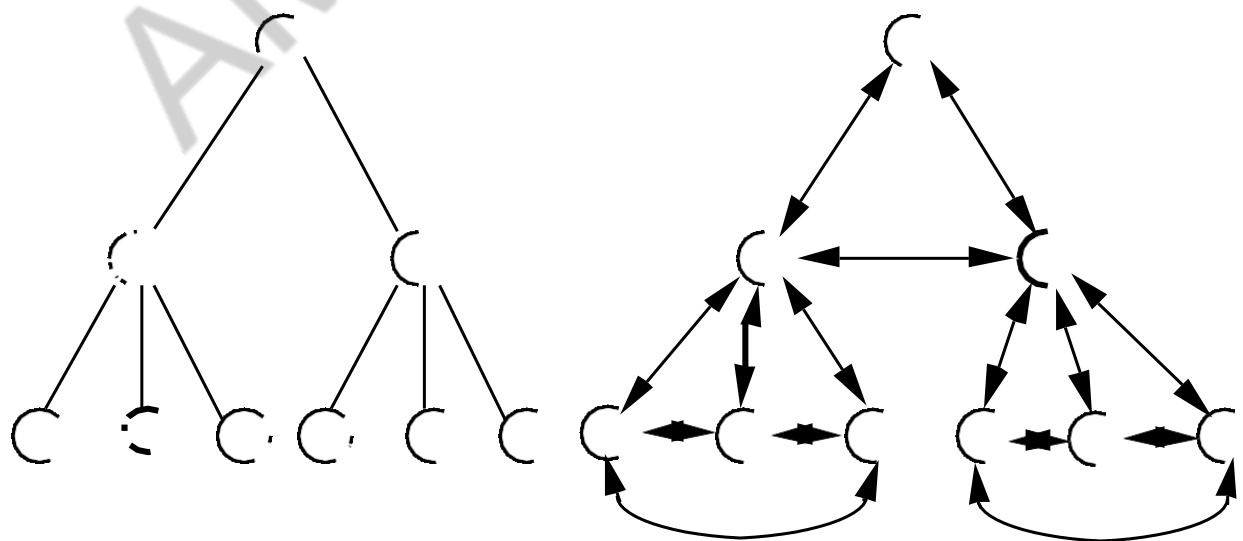

	<ul style="list-style-type: none"> ❖ The mixed team organization, as the name implies, draws upon the ideas from both the democratic organization and the chief-programmer organization. This team organization incorporates both hierarchical reporting and democratic set up. ❖ The democratic connections are shown as dashed lines and the reporting structure is shown using solid arrows. ❖ The mixed control team organization is suitable for large team sizes. ❖ The democratic arrangement at the senior engineer's level is used to decompose the problem into small parts. Each democratic setup at the programmer level attempts solution to a single part. Thus, this team organization is eminently suited to handle large and complex programs. <p>This team structure is extremely popular and is being used in many software development companies.</p>
9	<p>Explain in detail about communication genres.</p> <ul style="list-style-type: none"> ❖ The nature of the information to be conveyed: <ul style="list-style-type: none"> ✓ What is the extent and complexity of the information to be conveyed? <ul style="list-style-type: none"> ➤ A phone conversation if message is simple ✓ Is it easy to understand? Is the context well known to both the sender and the recipient? <ul style="list-style-type: none"> ➤ Two way communication ✓ Where the communication is personally sensitive <ul style="list-style-type: none"> ➤ Face-to-face contacts ❖ At different stages of a project - different communication genres will be preferred ❖ Early stages - meeting(s) <ul style="list-style-type: none"> ✓ Team members need to build up their trust and confidence in their co-workers ✓ Decision making ❖ Intermediate stages (design) - teleconferencing <ul style="list-style-type: none"> ✓ Activities executed in parallel ✓ Some points needs to be clarified ❖ Implementation stages - emails <ul style="list-style-type: none"> ✓ Everyone knows his role, work can progress <p>Face to face meetings - helps coordination and maintain motivation</p>

10	<p>Write a short note on i) communication plans and ii) virtual teams.</p> <p>i) communication plans</p> <p>A communications plan, in project management, is a policy-driven approach to providing stakeholders with information about a project. The plan formally defines who should be given specific information, when that information should be delivered</p>
----	--

	Same place	Different places
Same time	Meetings, Interviews	Telephone, instant messaging
Different times	Noticeboards, pigeon-boards	E-mail, voicemail, documents

and what communication channels will be used to deliver the information.

An effective communications management plan anticipates what information will need to be communicated to specific audience segments. The plan should also address who has the authority to communicate confidential or sensitive information and how information should be disseminated (email, web sites, printed reports, and/or presentations). Finally, the plan should define what communication channels stakeholders should use to provide feedback and how communication documentation will be archived as part of the project records.

In some organizations the communications management plan may also include a glossary of common project terminology that will be used within the project. This glossary may define and include samples of templates, reports and forms that the project manager will use to communicate information.

Audience

The project team must identify all audiences that will receive communications. In a large company, information technology project communications delivered to technical and development teams would vary widely from information provided to senior management, middle management or administrative staff. Other examples of various audiences within a large organization would be staff appointed to conduct end user testing or to write end user documentation.

Information Needs

Whether communications are distributed only to technical or functional teams, or address a wider audience, each message delivered should be prepared for a specific target audience. If a number of different audiences with different needs exist, the content of each message should also be varied for the intended recipients. An example in information technology would be communications of technical specifications that would be delivered to developers. This same information would not be delivered to all end user systems testers, only those responsible for documentation.

Media

Though electronic communications such as email may be the most efficient means of communication, it is not always the most effective in communications of project information or to deliver training. The project team should also consider newsletters, video feeds or webinars. Group presentations and town hall meetings to provide for question-and-answer sessions can also be provided to communicate project goals, user training or project results.

Timing

Communications for any project should start in the planning stages. Though the initial phases of communication will not be as robust as those near the end of a project, the initial step of broadcasting planned changes to any infrastructure or process is critical to receive buy-in from all parties. Information flow should be handled by the project team in coordination with senior management of an organization. This coordination is to define what information is to be delivered at various points during project progression.

Responsibilities

The project team may be responsible for all project communications, or a corporate communications unit could be called upon to provide assistance. However communications are handled, specific communications tasks should be assigned

starting in the planning phase of a project. Though roles may change during the life of

AMSCCE - 1101

a project, a plan for delegating communications duties must be crafted in advance.

ii) Virtual Team

A Virtual Team – also known as a Geographically Dispersed Team (GDT) – is a group of individuals who work across time, space, and organizational boundaries with links strengthened by webs of communication technology. They have complementary skills and are committed to a common purpose, have interdependent performance goals, and share an approach to work for which they hold themselves mutually accountable. Geographically dispersed teams allow organizations to hire and retain the best people regardless of location. A virtual team does not always mean teleworkers. Teleworkers are defined as individuals who work from home. Many virtual teams in today's organizations consist of employees both working at home and small groups in the office but in different geographic locations.

Why Virtual Teams?

- ❖ Best employees may be located anywhere in the world.
- ❖ Workers demand personal flexibility.
- ❖ Workers demand increasing technological sophistication.
- ❖ A flexible organization is more competitive and responsive to the marketplace.
- ❖ Workers tend to be more productive – less commuting and travel time.
- ❖ The increasing globalization of trade and corporate activity.
- ❖ The global workday is 24 vs. 8 hours.
- ❖ The emergence of environments which require inter-organizational cooperation as well as competition.
- ❖ Changes in workers' expectations of organizational participation.
- ❖ A continued shift from production to service/knowledge work environments.
- ❖ Increasing horizontal organization structures characterized by structurally and geographically distributed human resources.