

Unit - I

Wireless Channels

PART A

1. What is meant by multipath propagation?

The signal can get from the Transmitter to the receiver through different propagation paths. Each of the paths has a distinct amplitude delay and direction of arrival.

2. Significance of propagation model.

- (i) Propagation model predicts the parameter of receiver.
- (ii) It predicts the average received signal strength at a given distance from the transmitter.

3. Define Doppler shift.

If the receiver is moving towards the source then the zero crossing of the signal appears faster and the received frequency is higher. So the result is Doppler shift.

4. Compare Slow fading and Fast fading.

| Slow Fading | Fast Fading |
|--|---|
| Slow variations in signal strength | Rapid variations in the signal strength |
| It occurs when the large reflectors and diffracting objects along the path | It occurs when the user terminal (MS) move for short distances. |

5. Explain path loss.

The path loss is defined as the difference between the effective transmitted power and the received power.

6. Define EIRP

It is defined as the transmitter power that is needed with an isotropic radiator to produce the same power density in the given direction.

$$\text{EIRP} = P_t G_t.$$

7. What are the three basic propagation mechanisms?

- (i) Reflection (ii) Diffraction (iii) Scattering.

8. What are the effects of fading.

- (i) Rapid changes in signal strength over a small travel distance (or) time interval.
- (ii) Random frequency modulation due to varying Doppler shifts on different multipath signals.

9. What is flat fading?(NOV/DEC 2017)

If the mobile radio channel has a constant gain and linear phase response over a bandwidth which is greater than the bandwidth of the transmitted signal.

10. What is frequency selective fading?

If the channel possesses a constant gain & linear phase response over a bandwidth which is smaller than the bandwidth of the transmitted signal.

11. What are the factors influencing small scale fading?

Multipath propagation.

Speed of mobile

Speed of surrounding objects.

Transmission bandwidth.

12. What is meant by small and large scale fading?(APR/MAY 2015)

The rapid fluctuations of the amplitude, phase (or) multipath delays of a radio signal over a short period of time It is called. 'Small fading'.

The rapid fluctuations of the amplitude phase (or) multipath delays of a radio signal over a long period of time. It is called as 'Large scale fading'.

13. What is reflection.

Reflection occurs when a EM wave impinges upon a object which has very large dimension when compared to the λ of the propagating wave.

14. What is diffraction?

Diffraction occurs when the radio path between the transmitter and receiver is obstructed by a surface that has sharp irregularities.

15. What is scattering?

Scattering occurs when the medium through which the wave travels consists of objects with dimensions that are small compared to the wave length.

16. Define Coherence time.(APR/MAY 2017) (NOV/DEC 2015)

For an electromagnetic wave, the *coherence time* is the *time* over which a propagating wave (especially a laser or maser beam) may be considered *coherent*, meaning that its phase is, on average, predictable

PART – B

1. Explain the free propagation models.

Definition:

Free space propagation model refers to the measurement of received signal when the transmitter and receiver of the communication system have clear, line of sight in between the two. It also infers that there is no obstacle in between the transmitter & receiver.

Application Area:

1. Microwave radio lines.
2. Satellite communication.

Frii Free space equation

$$P_R (d) = \frac{P_T G_T G_R \lambda^2}{(4\pi)^2 d^2 L}$$

where d – is the distance between transmitter and receiver antenna.

G_T - Gain of the receiver antenna

P_T - Transmitter power

G_R - Gain of the receiver antenna

d - Distance /Separation between Transmitter and Receiver antenna

L - System loss factor

λ - Wave length

considering ‘Ae’ as effective aperture,

$$G = \frac{4\pi Ae}{\lambda^2}$$

The wavelength = $\lambda = \frac{C}{F} = \frac{2\pi C}{\omega_c}$

EIRP = $P_T \cdot G_T$

Path loss:

$$P_L (dB) = 10 \log \left(\frac{P_T}{P_R} \right)$$

$$P_L (dB) = -10 \log \left(\frac{G_T G_R \lambda^2}{(4\pi)^2 d^2} \right)$$

Fraunhofer Region:

$$d_F = \frac{2D^2}{\lambda}$$

where $D \rightarrow$ Largest linear dimension of the antenna element.

two conditions:

1. $d_F \gg D$
2. $d_F \ll \lambda$

2. Explain Ground reflection (Two Ray) model.(NOV/DEC2015)

The two-ray ground reflection model is a useful propagation model that is based on geometric optics and considers both the direct path and ground reflected propagation path blue Tx & Rx.

The total receiver E field = E_{tot}

The direct line of sight = E_{los}

Ground reflected = E_g

Free space E field = E_o (units of V/m)

Reference distance = d_o

From tx, $d > d_o$, , the free space propagation E field

$$E_{(d,t)} = \frac{E_o d_o}{d} \cos \left(\omega_c \left(t - \frac{d}{c} \right) \right) \quad (d > d_o)$$

$$\text{Where } (E(d, t)) = \frac{E_o d_o}{d}$$

Two propagation waves arrive at the receiver, the direct waves that travel a distance d' & the reflected waves that travels a distance d'' .

$$E_{los}(d', t) = \frac{E_o d_o}{d'} \cos \left(\omega_c \left(t - \frac{d'}{c} \right) \right)$$

$$E_g(d'', t) = \frac{E_o d_o}{d''} \cos \left(\omega_c \left(t - \frac{d''}{c} \right) \right)$$

According to laws of reflection in dielectrics

$$\begin{aligned}\theta_i &= \theta_0 \\ E_g &= \Gamma E_i \\ E_t &= (1 + \Gamma) E_i\end{aligned}$$

Where Γ is the reflecting coefficient for ground.

$$\Gamma = -1 \text{ and } E_i = 0.$$

$$|E_{\text{tot}}| = |E_{\text{los}} + E_g|$$

$$E_{\text{tot}}(d, t) = \frac{E_0 d_0}{d'} \cos\left(\omega_c \left(t - \frac{d'}{c}\right)\right) + (-1) \frac{E_0 d_0}{d''} \cos\left(\omega_c \left(t - \frac{d''}{c}\right)\right)$$

3. Explain link budget design using path loss model log distance path loss model log-normal shadowing. (Nov/DEC 2017)

$$\bar{P}_r(d) \propto \left(\frac{d}{d_0}\right)^n$$

$$\begin{aligned}\text{Or } \bar{P}_r(\text{dB}) &= \bar{P}_L(d) + X_\sigma \\ &= \bar{P}_L(d_0) + \omega_n \log\left(\frac{d}{d_0}\right) + X_\sigma\end{aligned}$$

$$\text{And } P_r(\text{dB}_m) = P_t[\text{dB}_m] - P_L(d)[\text{dB}]$$

Where X_σ is a zero means gaussian an distributed random variable in (dB) in standard deviation σ . The log normal distribution discrete the random shadowing effect which occur over a large no of measurement location which have the same T=R separation.

$$\text{The received signal } P_r[P_r(d) < \gamma] = Q\left(\frac{\bar{P}_r(d) - \gamma}{\sigma}\right).$$

4. Explain Link Budgets Design using path loss models. Determination of percentage of coverage area.

It is clear that due to random effect of shadowing, some location with in a coverage area will be before particular desired received signal threshold.

It is often useful to complete how the boundary coverage related to the prevent of area covered with in the boundary.

$R \rightarrow$ circular area having radius from a base station

$U(\gamma) \rightarrow$ the % of useful service area.

$(\gamma) \rightarrow$ desired received signal threshold.(i.e, the% of area with a Received signal that is equal or greater than γ)

Let $d=r$, radial distance from the transmitter

$P_r [P_r (r) > \gamma]$ is the probability that the random receiver signal at $d=r$ exceeds the threshold γ with in an incremental area dA .

$$U(r) = \frac{1}{\pi R^2} \int P_r [P_r > \gamma] dA$$

$$= \frac{1}{\pi R^2} \int_0^{2\pi} \int_0^R P_r [P_r (r) > \gamma] r dr d\theta$$

$$U(r) = \frac{1}{2} \left[1 + \exp\left(-\frac{1}{b^2}\right) \left(1 - \exp\left(-\frac{1}{b}\right) \right) \right]$$

5.Explain in detailed about parameter of mobile multipath channel.(APR/May 2015)

1. Time dispersion parameters.
2. Coherence bandwidth
3. Doppler spread and coherence time

1.Time dispersion parameters:

The mean excess delay rms delay and delay spread (x dB) are multi path channel parameters that can be determine from a power delay profile

Mean excess delay = $\bar{\tau}$

Rms delay spread = (σ_τ)

The mean excess delay is the first moment of the power delay profile and is defined to be

$$\bar{\tau} = \frac{\sum_k a_k^2 \tau_k}{\sum_k a_k^2} = \frac{\sum_k P(\tau_k) \tau_k}{\sum_k P(\tau_k)}$$

the rms delay spread is the square root of the second central moment of

the power delay and is defined to be

$$\sigma_\tau = \sqrt{\overline{\tau^2} - (\bar{\tau})^2}$$

where $\overline{\tau^2} = \frac{\sum_k a_k^2 \tau_k^2}{\sum_k a_k^2} = \frac{\sum_k P(\tau_k) \tau_k^2}{\sum_k P(\tau_k)}$

6. Explain in the detail about fading effect due to multipath time delay spread.(APR/MAY 2015) (NOV /DEC 2017)

1. Flat fading
2. Frequency selection fading

Types :

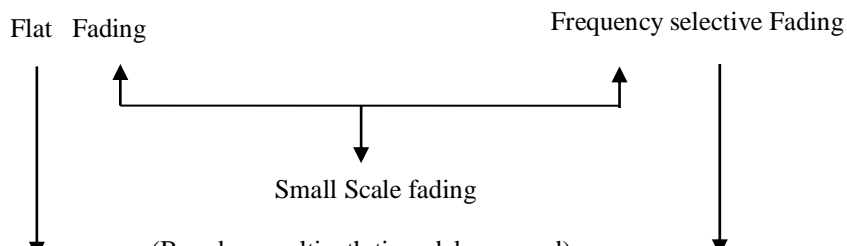

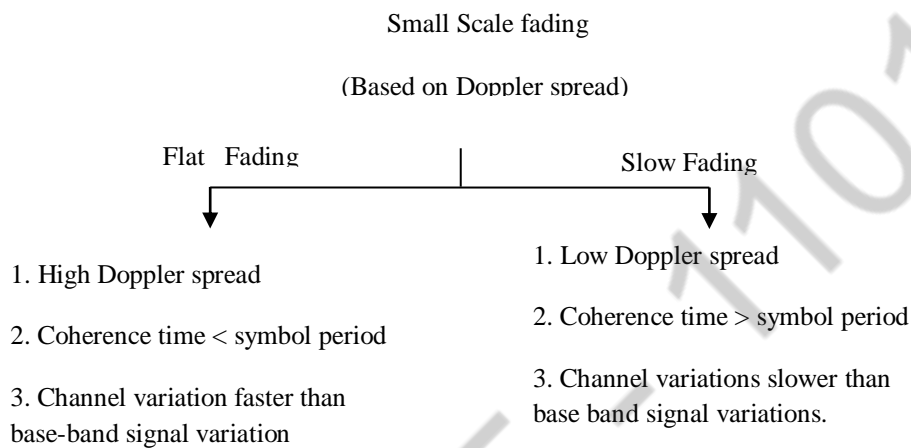

1. Flat fading:

The multipath structure of the channel is such that the spectral characteristic of the transmission signal are preserved at the receiver.

$$B_s \ll B_c.$$

And $T_s \gg \sigma_\tau$ where T_s the reciprocal of B_s eg: symbol period. B_s is bandwidth, σ_τ and B_c is rms delay spread and coherence bandwidth.

2. Coherence bandwidth (B_c):

B_c is a defined relation delivered from the rms delay spread,

$\sigma_\tau \rightarrow$ rms delay spread.

$$B_c \approx \frac{1}{50\sigma_\tau}$$

If the definition is relaxed so that the frequency correlation function is above 0.5 then the coherence bandwidth is approximately

$$B_c \approx \frac{1}{5\sigma_\tau}$$

3. Doppler spread and coherence Time.

Doppler spread and coherence time are parameter which describe the time varying nature of the channel in a small scale region.

$B_d \rightarrow$ Doppler spread

When a pure sinusoidal tone of frequency f_c is transmitted the receiver signal spectrum called the Doppler spectrum. Range $f_c - f_d$ to $f_c + f_d$.

Where f_d is the dopper shift. If the baseband is much greater than B_d , the effects of dopper spread are negligible at the receiver this is slow fading channel.

$$t_c \approx \frac{9}{16\pi f_m} \quad \text{where } f_m = \text{max Doppler shift} \quad f_m = \frac{V}{p}$$

Flat fading channel characteristic

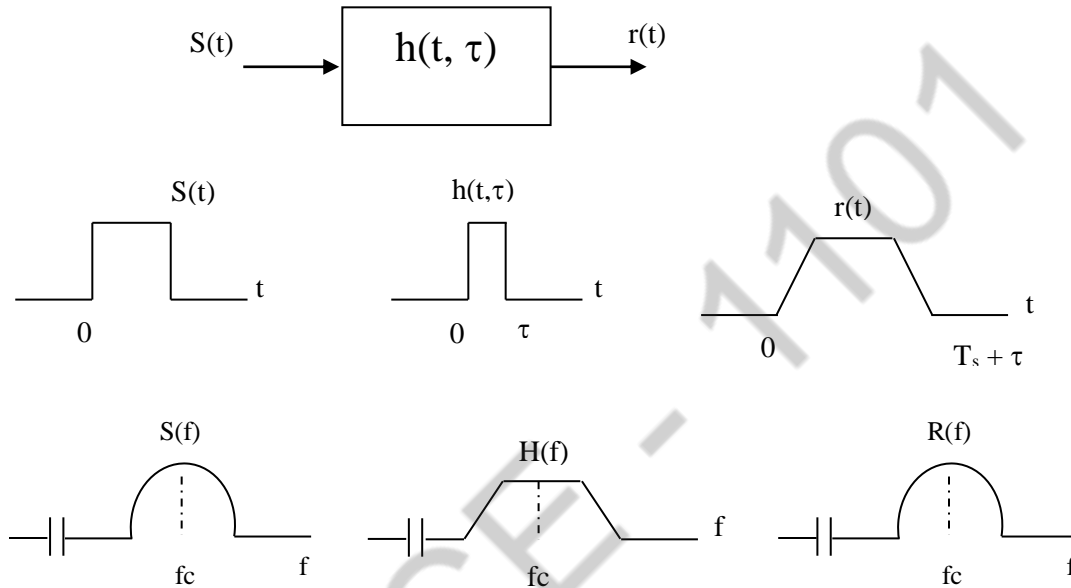

Frequency selective fading:

If the channel posses sa constant gain and linear phase response over a but that is small then the bus of fixed signal, then the channel creates frequency selective fading on the receiver signal.

- $B_s > B_c$
- and $T_s < \sigma_\tau$
- T_s – reciprocal bus,
- B_s -Bus,
- σ_τ and B_c is rms delay.

Frequency selective fading channel spread and coherence bandwidth characteristics.

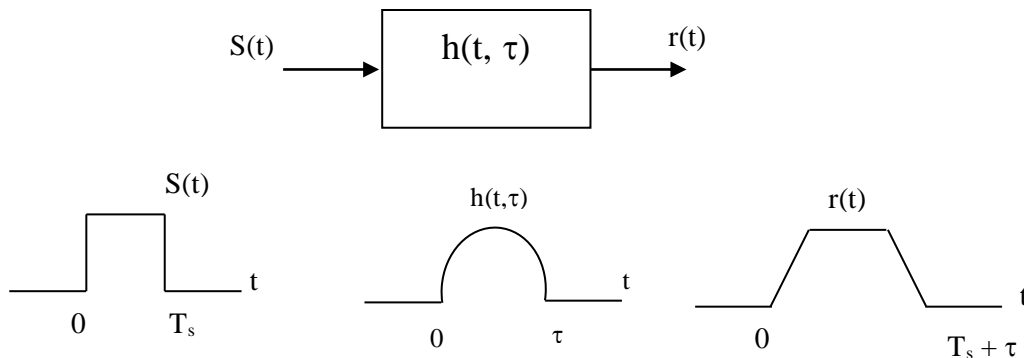

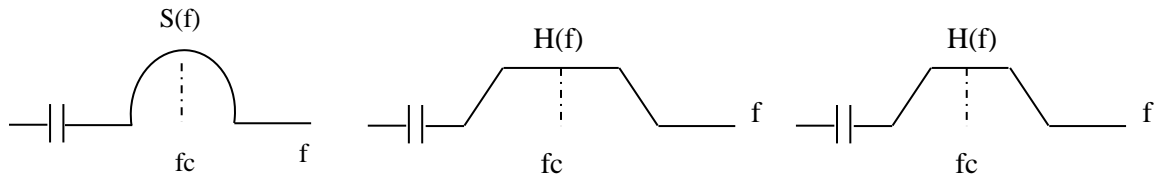

7. Explain in detailed about fading effect due to Doppler spread.

1. Fast fading
2. Slow fading

Fast fading:

- * The channel impulse response changes rapidly within the symbol duration
 $T_s > T_c$
and $B_s < B_d$
- * Fast fading only deals with the rate of change of the channel due to motion, frequency selective fast fading channel the amplitudes phase and time delay of any one of the multipath compounds very faster than the rate of change of transmission signal.
- * Fast fading only occurs for very low data rate.

Slow fading:

The channel impulse response at a rate much slower than the transmission baseband signal $s(t)$ in the frequency domain.

Doppler spread of the channel is much less than the bus of the baseband signal

$$T_s \ll T_c$$

$$\text{and } B_s \gg B_d.$$

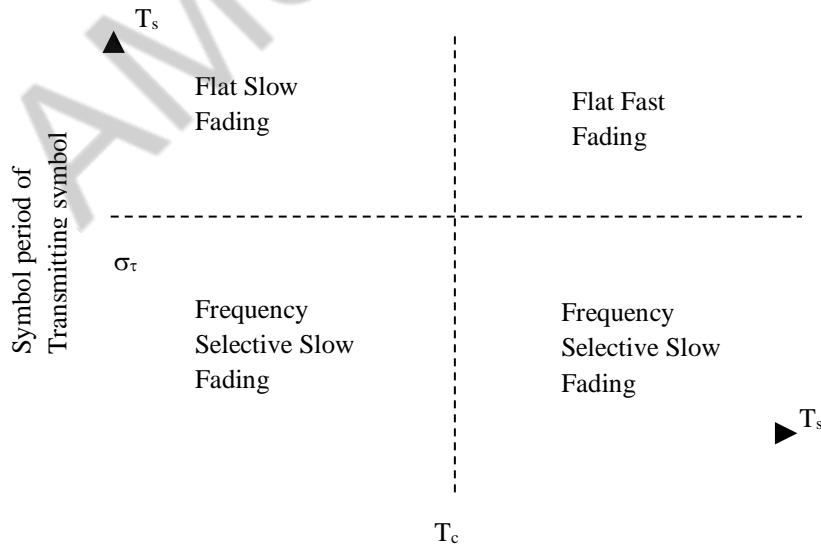

a) Transmitted symbol period

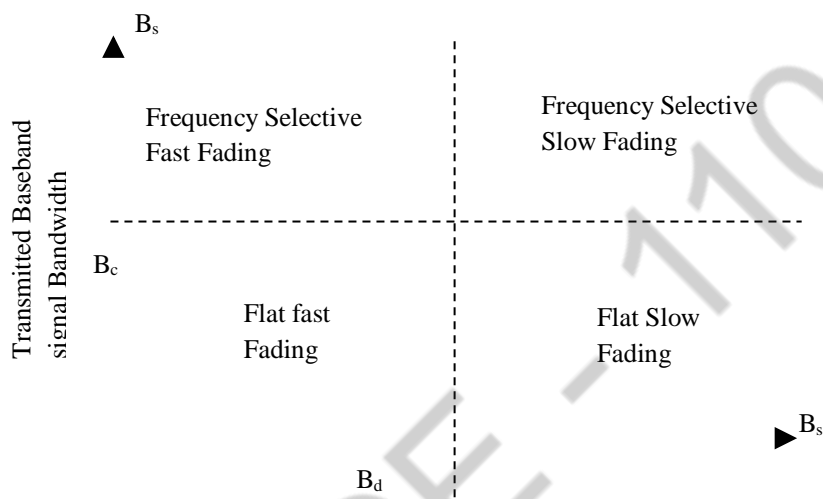

b) Transmitted Baseband signal Bandwidth

Unit –II
Cellular Architecture
PART A

1. What is base station?

A fixed station in mobile radio system used for radio communication with mobile. It has transmitter and receiver section.

2. What is MSC?

Mobile switching centre coordinates the routing of calls in large service area. It connects the base station and mobiles to PSTN.

3. What is meant by forward and reverse channel?(NOV/DEC 2017)

Forward channel is a radio channel used for transmission of information from base station to mobile.

Reverse channel is a radio channel used for transmission from mobile to base station.

4. What is the function of control channel? What are the types.

Control channel is used for transmission of call setup, call request, call irritation & control.

Types: (i) Forward control channel

(ii) Reverse control channel

5. What is meant by cell?

Each cellular base station is allocated to a group of radio channels to be used within a small geographic area called as cell.

6. What is channel assignment? What are the types.

A channel assignment is used for efficient utilization of radio spectrum of frequency reuse scheme with increasing capacity.

7. What is fixed channel assignment?

If the channels in each cell are allocated to the users within the cell. It will be called as fixed channel assignment.

8. What is dynamic channel assignment?

If the voice channels are not allocated permanently in a cell. It will be called as dynamic channel assignment. In this assignment, channels are dynamically allocated to users by the MSC.

9. Define cell splitting.

Cell splitting is the process of subdividing congested cells into small cells each with its own base stations and a corresponding reduction in antenna height & Transmitted power,

10. What is sectoring?

Sectoring is a technique for decreasing co-channel interference and thus increasing the system performance by using directional antennas.

11. Define frequency reuse? (NOV/DEC 2017)

It is the process of using the same radio frequencies on radio transmitter with a geographic area separated by sufficient distance to cause minimal interference. It allows more number of users with in a geographic area on a limited amount of radio spectrum.

12. Define Grade of service. (NOV/DEC 2015)

It is defined as the measure of the ability of a user to access a trunked system during peak hours.

13. What is blocked call clear system.

In a system, a user is blocked without access by a system when no channels are available in the system. The call blocked by the system is cleared and the user should use again.

14. What is blocked call delay system?

If a channel is not available immediately, the call request may be delayed until a channel becomes available.

15. Define co-channel reuse ratio. (NOV/DEC 2015)

It is defined as the ration of the distance between the centers of nearest co-channel cells to the radius of the cell $Q = D/R$.

PART - B

1. Explain the different multiple access techniques (NOV/DEC 2017)

Multiple access techniques.

The radio spectrum is shared by the mobile users simultaneously the sharing may be based on frequency time and code

Ex: Frequency division duplexing (FDD)

Different multiple access schemes (Techniques)

1. Time division multiple access –TDMA
2. Code division multiple access – CDMA
3. Frequency division multiple access – FDMA
4. Space division multiple access – (SDMA)

Frequency division multiple access:

The individual users are allotted individual channels. The channel or frequency band is unique for each user (subscriber). The separation in frequency between the forward and reverse channel is constant in the entire system for all the channels.

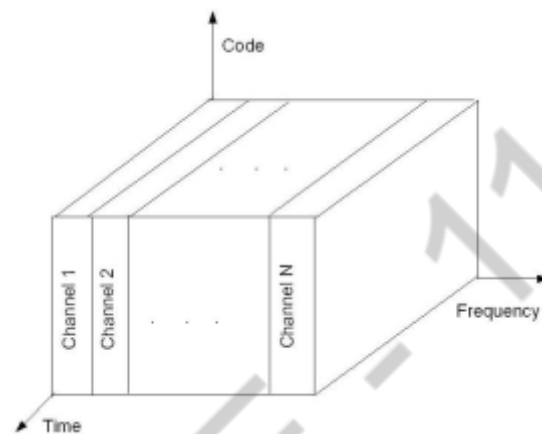

Fig: Basic concept of FDMA

Features:

- i. FDMA required proper filtering at receiver side to avoid adjacent channel interference (ACI)
- ii. In FDMA scheme if a channel is not in use it will be and it will not be used by some other users. Hence there is a change of resource wastage.
- iii. FDMA channel can handle one phone circuit at a time
- iv. Complexity is less.
- v. Narrow bandwidth,

Time division multiple access :

In time division duplexing utilize time instead of frequency, several user share the time slot of the entire time available. Each user is allocated a time slot in which it can access the channel.

Each duplex channel (TDD) has individual time slots to the bidirectional communication

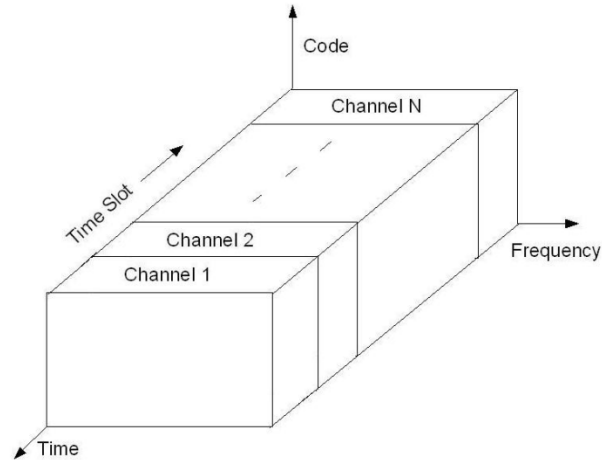

Fig: Basic concept of TDMA

Features

Each user in TDMA multiple access scheme shares some carrier frequency but with non overlapping time slots.

Code division multiple access:

In CDMA techniques many user share the same carrier frequency (f_c). The narrow band message signal is also multiplexed with a spreading signal of larger B_w .

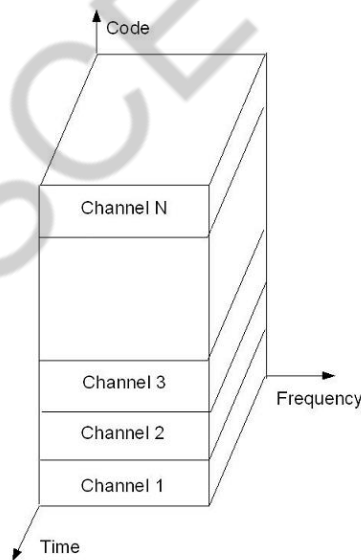

Fig: Basic concept of CDMA

Some features:

1. If the spreading sequence are not exactly orthogonal from one user and to another user there may be a chance of self jamming problem in CDMA.
2. Radio signal strength indicator (RSSI) is being used in CDMA to have better power control.
3. CDMA has better soft capacity limit than TDMA and FDMA methods.
4. CDMA has less interference problems due to allocation of unique codes to each user and this multiple access technique is applied for defence area than other multiple access techniques

Space division multiple access (SDMA):

Space division multiple access SDMA techniques is a better multiple access scheme that can be applied for wireless network.

Advantages:

1. With SDMA technique all the 3 subscribers can communication using the same channel in their system at a time.
2. Individual multi path component can be tracked efficiency if an ideal adaptive antenna system is used.

2. Compared of multiple access techniques:

| S.No | Approach | TDMA | FDMA | CDMA | SDMA |
|------|-------------------|---|--|---|---|
| 1. | PRINCIPLE | Message sending time into disjoint time slot fixed pattern /demand driven | Message is in different segment of frequency as disjoint sub bands | Spreads the spectrum using orthogonal codes | Segment space into sectors /cells |
| 2 | TERMINALS | All the terminals are active for short time periods on same frequency | Every terminal has its own frequency which is uninterrupted | All the terminal are active at same moment which is uninterrupted | Only one terminal is active in one sector one cell. |
| 3 | SIGNAL SEPERATION | Synchronisation is done in time done | Filtering in frequency domain is done | Code plus specified receivers arrangement | Director antennas cell structure |
| 4 | ADVANTAGE | Full digital in nature Flexible Easy to established | Robust easy establishment simple | Flexible soft handover Less planning is enough | Simple increase the capacity |

| | | | | | |
|---|--------------------|------------------------|--|---------------------------------|-------------------------------------|
| 5 | DIS - ADVANTAGE | Required a guard space | Not flexible | Receivers are complex in nature | |
| 6 | APPLICATION | Used in mobiles | Combined with TDMA /SDMA for hopping and reuse | Integrated with TDMA/FDMA | Combination with TDMA |
| 7 | SCHEME | Time slices are used | Frequency slices | Individual codes for each uses | Requirement in space in each sector |

3. Explain the concept frequency Reverse:

- Frequency reverse is the techniques used to cover the entire area with the limited spectrum.
- The total available channels will be divided into small group (cluster) and will be provided to the base stations.
- It is assigned such a way to prevent any interference.
- Adjacent base station complexity diffece4nt channels than neighbouring cells.
- The splitting up of cell then it has to satisfy $N = i^2 + ij + j^2$ here i,j are nonzero integers
- Clusters are group of cells which share the entire spectrum.
- 7 cell reuse concept.

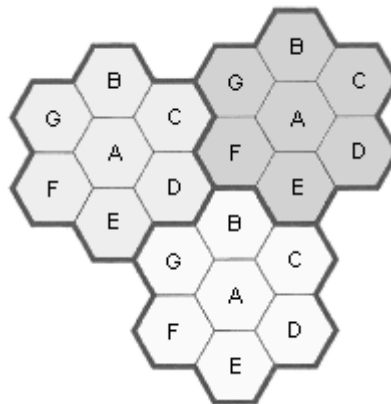

Cells with the same letter use the same set of frequencies.

4. Explain Hand off.(apr/may 2017)

Soft hand off :

During soft hand off a mobile station is in the overlapping cell coverage area of two sections belongs to two different base stations. The communication between mobile station and base station occurs concurrently rake processing soft hand off occurs in about 20-40% of cells.

Soft hand offs are integral part of CDMA design. The active set of the pilots associated with units.

The candidate set consists of the pilots that the mobile unit has reported are of a sufficient signal strength to be used. Thus mobile unit also promotes the neighbour set and remaining set pilots that meet the criteria to the candidate set. The neighbour set is list of the pilots in the mobile unit.

5. Explain interference in wireless communication.

- * Co channel interference
- * Adjacent channel interference

Co-channels interference:

Cells that use the same set of frequencies are called co channel cells. The interference between signals from these cells is called co channel interference. To reduce co channel interference co channel cells must be physically separated by a minimum distance to provide sufficient isolation due to propagation

Adjacent channel interference:

Interference resulting from signals which are adjacent in frequency to the desired signal is called adjacent interference. Adjacent channel interference results from imperfect receiver filter which allow nearby frequency to leak into the pass band

Adjacent channels interference can be minimized by keeping the frequency separation between each channel in a given cell as large as possible.

Trunking:

In trunking radio system there is no connection between the wireless call taxi.

Coverage and capacity improvement:

Sectoring:

Each cell into three or six sectors which are then served by three or six separate directional antennas. Each with beam width of about 120 or 60 degree.

Micro cells:

The smaller R also has the benefit that transmitted power would be cut by a factor.

For example: Consider an original microcell grid next to an inset micro cell area. There is a confident cells that were separated by distance $R\sqrt{3N}$ for the initial r are no longer separated by that much.

Repeaters:

Used to increase the coverage area partially into building turned and canyons.

6. Explain the spread spectrum and CDMA system.

Concept of spread spectrum:

In a wide band spread spectrum (SS) system when spectrum spreading is performed by phase modulation. The DSSS is the averages techniques to reduce interference where as FHSS and TASS are avoiding techniques to minimized interference.

Critical challenge of CDMA:

CDMA is based on DSSS. CDMA is a more Complex than other multiple access techniques and such poses several critical challenges.

Downlink Forward (BS to MS)

The down link channels include one pilot channel one synchronization channel and 62 other channel including upto 7 percentage channels.

Up link reverse (MS to BS)

The uplink channel is separated from down link channel by 45 MHz at cellular frequencies and 80 MHz At PCS frequencies (1.8 to 1.9 Hz).

Power Control in CDMA:

- A proper power control on both the uplink and down link has several advantages: system capacity is improved of optimized. Mobile battery life is extended.
- Radio path impairments are properly compensated for (Qos) Quality of Service at various bit rates can be maintained.

Open loop power control

In the loop power control, the mobile uses the Received signal to estimate the txion less from the mobile unit and the base station.

$$T(r) = 10 \log \frac{P_r(r)}{P_t}$$

$$L(r) = T(r) - G_t - G_r$$

Where

P_t = transmitters power output.

$P_r(r)$ = received at distance r from the transmitter.

$G(t)$ = Antenna gain of transmitter.

Unit-III

Digital signalling for fading channels

PART A

1. What is QPSK?

It is a 4-ary PSK signal. The phase of the carrier in the QPSK takes 1 of 4 equally spaced shifts. Two successive bits in the data sequence are grouped together.

1 symbol = 2 bits.

2. What is meant by MSK?

A continuous phase PSK signal with a deviation ratio of one half is referred to as MSK.

3. List the advantages of digital modulation techniques.

- (i) Immunity to channel noise and external interference.
- (ii) Security of information.
- (iii) Flexibility.
- (iv) Multiplexing of various sources.

4. What is Linear modulation.

In this modulation, the amplitude of the transmitted signal varies linearly with the modulating signal.

5. Define non linear modulation?

In this type, the amplitude of the carrier is constant regardless of the variation in the modulating signals.

6. What is the need of equalization?

It is used to compensate the inter symbol interference created by multipath with in time dispersion channel.

7. Why MSK cannot be directly used in multi user communication.

- (i) The main lobe of MSK is wide. So this makes unsuitable for system where extremely narrow bandwidth and sharp cut off are required.
- (ii) Slow decay of MSK power spectral density curve creates adjacent channel interference.

8. What is the need of Gaussian filter?

It is used to reduce the transmission bandwidth. It user less bandwidth than conventional FSK.

9. Give some examples for constant envelope modulation.

BFSK, MSK, GMSK.

10. List the advantages of GMSK.

- (i) It has improved spectral efficiency.
- (ii) It can be amplified by a non-linear amplifier and remain uninstructed.

11. Define PAPR.

It is the peak Amplitude squared (peak power) divided by the RMS value squared (Average power).

12. What is OFDM?(APR/MAY 2017)

Orthogonal frequency division multiplexing splits the information into N parallel streams which are then transmitted by modulating N distinct carriers. In order to separate the sub-carriers by the receiver.

13. What are advantages of offset – QPSK.

- (i) It is to suppress out off and interference.
- (ii) It will limit the phase shift to not more than 90 at a time,

14. Define off set QPSK & $\pi/4$ differential QPSK.

In offset QPSK: The amplitude of data pulses are kept constant. The time alignment of the even & odd bit streams are offset by one bit period.

In $\pi/4$ QPSK: Signalling points of the modulated signal are selected from two QPSK constellations which are shifted by $\pi/4$ with respect to each other.

PART B

1. Draw and explain the structure of wireless communication link.

- * The aim of this link is to transmit information from analog source through an analog wireless propagation channel to the destination link.
- * To increase the link reliability digitizing of information is done.
- * The sequence of operations are.

TX:

- Source coding
- Channel coding
- Modulation procedure
- Applying multiple access
- Transmitting through channel/media

Rx:

- Signal combining diversity technique

- Equalization
- Demodulation procedure
- Channel decoding
- Source decoding
- Signal reception at link.

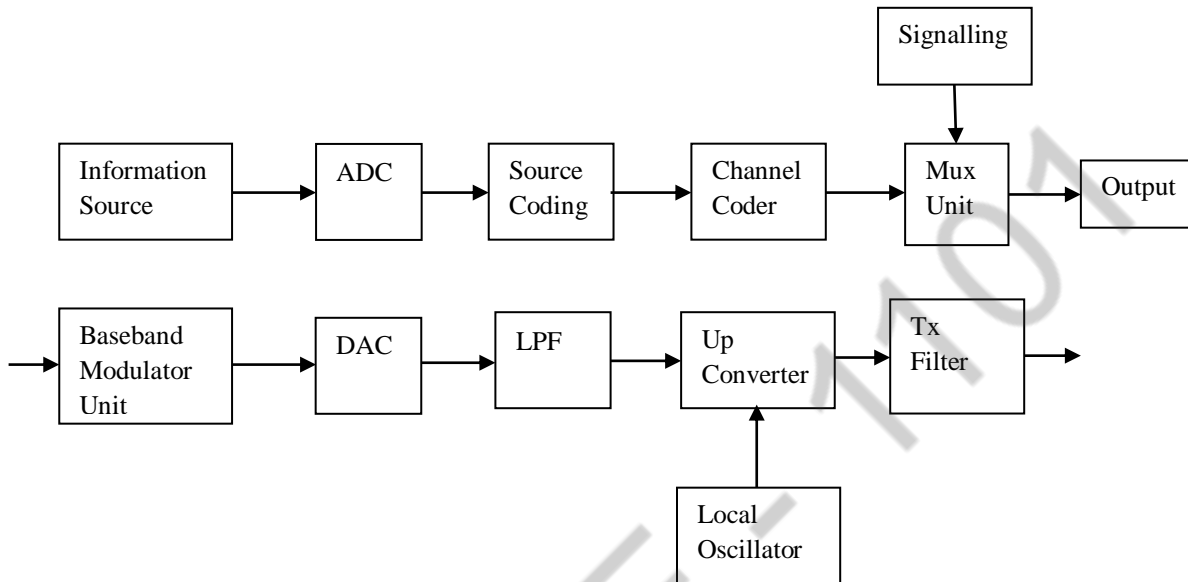

Fig: Radio link with digital Tx and Rx.

- * The source coder is used to reduce redundancy in the source signal. It reduces the source data that has to be transmitted.
- * For example in GSM cellular standard the source data rate is reduced is from 64kb/sec to 13kb/sec.
- * The channel coder appends redundancy to protect data from transmission errors.
- * Using channel coding in GSM the data rate is increased from 13kb/sec to 22.8kb/sec.

2. Explain the concept of Quadrative phase shift keying.(NOV/DEC 2017)

- * In QPSK consider 0, $\pi/2$ and $3\pi/2$ all equally spaced four values and phase value of carrier signal takes one of these four values.
- * Each value would correspond to unique pair of information bit.
- * The originals data stream is divided into two streams say a_{1i} and a_{2i} .

Let $a_{1i} = a_{2i}$
 $a_{2i} = a_{2i} + 1$

has data rate which is half of the original data stream;

$$R_s = \frac{1}{T_s} = \frac{R_B}{2} = \frac{1}{2T_B}$$

The basic pulses are rectangular pulses,

$$g(t) = g_R(t, T_s)$$

The two sequences of the pulses,

$$P_1D(t) = \sum_{i=-\infty}^{\infty} b_{1i} g(t - iT_s)$$

$$= b_{1i} * g(t)$$

$$P_2D(t) = \sum_{i=-\infty}^{\infty} b_{2i} g(t - iT_s)$$

$$= b_{2i} * g(t)$$

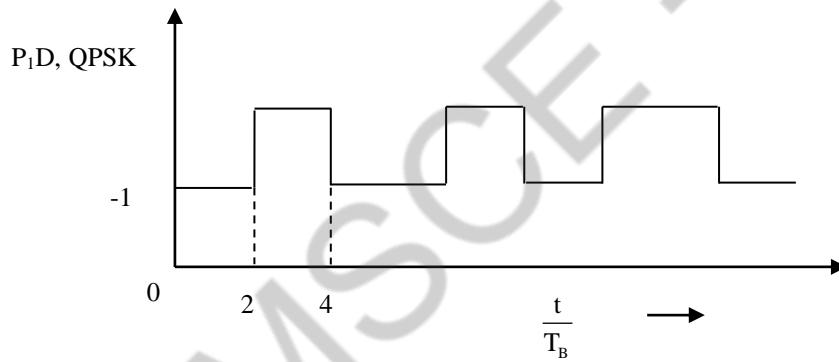

Fig: a)

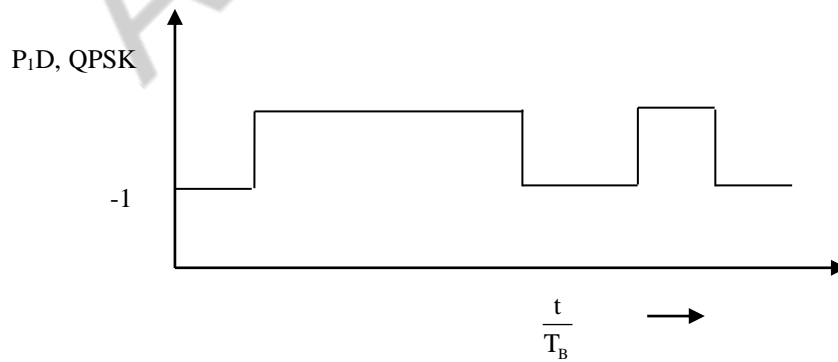

Fig: b)

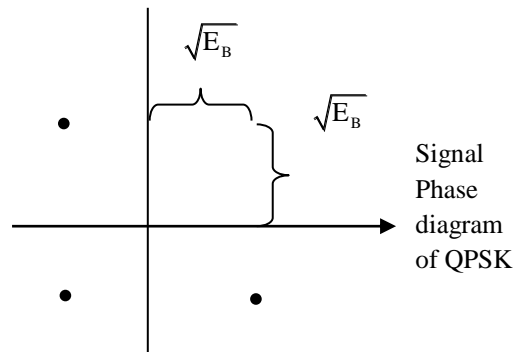

Fig: c)

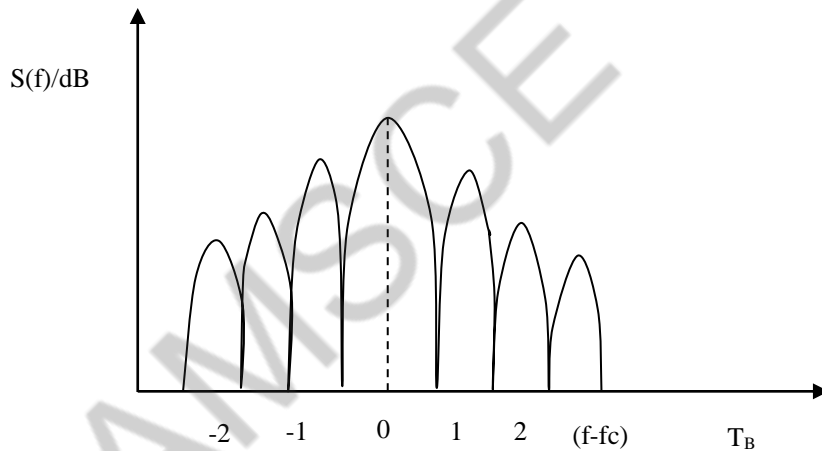

Fig: Normalized power speehal density in QPSK

- * Normalized can be done QPSK that the energy within a symbol interval is $2E_B$; (E_B energy expanded on txion of a bit).
- * The $s(f)/dB$ Versus $(f-fc) T_B$. When $(f-fc) T_B$ is zero the amplitude of the central lobe is maximum and it gradually reduces which is symmetrical on either side of this zero value.

3. Explain $\pi/4$ Differential quadrative phase shift keying.(NOV/DEC 2017)

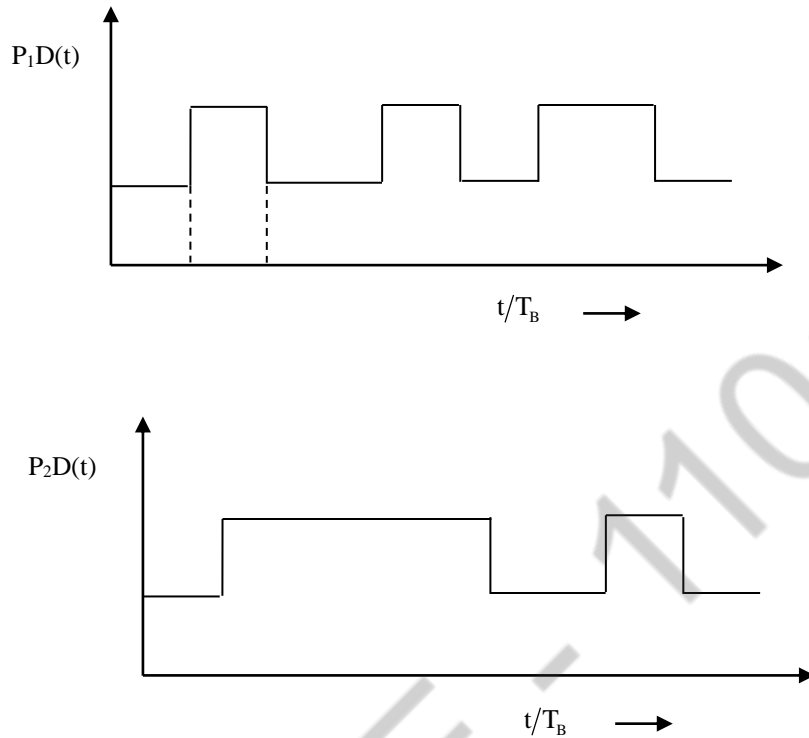

Fig: Basic pulses for offset QPSK technique

- ❖ To improve peak-to-average ratio in QPSK technique is to assure bit transitions for in-phase and quadrature - phase components occurs at various time instants it is called as OQPSK or offset QPSK. The sequence of basic pulses for the offset quadrative phase shift keying.
- ❖ The transitions for in-phase component occurs at the integer multiples of symbol duration when quadrative components occur 1 bits during later. The transmit pulse streams are.

$$\begin{aligned}
 P_1D(t) &= \sum_{i=-\infty}^{\infty} a_{1i}g(t - iT_s) \\
 &= a_{1i} * g(t) \\
 P_2D(t) &= \sum_{i=-\infty}^{\infty} a_{2i}g\left(t - \left(i + \frac{1}{2}\right)T_s\right) \\
 &= a_{2i} * g\left(t - \frac{T_s}{2}\right)
 \end{aligned}$$

4. $\pi/4$ Differential quadrature phase shift keying.

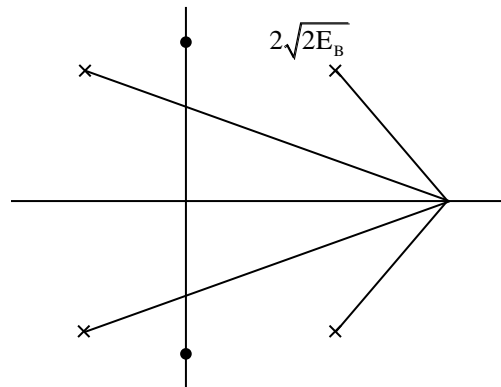

Fig: Transitions in signal space diagram in $\pi/4$ DQPSK technique

- * The QPSK is generally a constant envelope format and it has amplitude dips at the bit transitions
- * The trajectories in I-Q diagram passes through origin for every bit transitions.
- * Durations of dips is longer whenever non-rectangular pulses can be used.

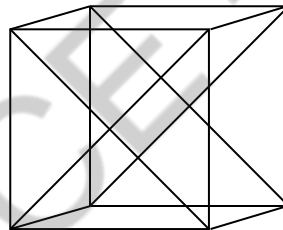

Fig: I – Q diagram of a $\pi/4$ DQPSK

- * The $\pi/4$ – DQPSK modulation format is one of the important suitable for wireless communication.
- * It is used in standards IS-136, IS-54 and cordless standards etc.
- * The principle of $\pi/4$ -DQPSK is simply shown in below constellation diagram. Here two sets of constellations are. (0,90,180,270) and (45,135,225,315)
- * All the symbols with even temporal index “i” are selected from set whereas all the symbols with odd index are selected from the second set.

5. Explain Minimum shift keying.(NOV/DEC 2017)(

- ❖ The minimum shift keying (MSK) is a special type of continuous phase frequency shift keying (CPFSK) techniques.
- ❖ Here the peak frequency deviation is one fourth of the bit rate.
- ❖ In CPFSK technique the modulation index is $m = 0.5$ or if the frequency spacing Δf is equal to $\frac{1}{2T_b}$ such a special case of CPFSK is termed as MSK.
- ❖ The frequency spacing Δf is the min shift that permits coherent detection of the orthogonal signals.
- ❖ On the otherhand MSK is also said to be a CPFSK with the modulation index as $m = 0.5$.

Let $S_1(t)$ and $S_2(t)$ be two signals and if they are orthogonal to each other, then they will satisfy

$$\int_0^T S_1(t) \cdot S_2(t) dt = 0 \text{ equation.}$$

The MSK tech is also termed as fast FSK. MSK is highly suitable for cellular mobile communication for an M-bit stream the MSK signal can be express as,

$$x_{msk}(t) = \sum_{i=0}^{M-1} n_i(t) p(A) \cos(\omega_c t) + \sum_{i=0}^{M-1} n_q(t) P(A-TA) \sin(\omega_c t)$$

Where $A = t - 2iT_b$.

and
$$p(t) = \begin{cases} \sin \frac{\pi t}{2T_b}; & 0 < t \leq 2T_b \\ 0 & \text{otherwise} \end{cases}$$

6. Explain Gaussian Minimum shift keying.(NOV/DEC 2015)

- * Gaussian (Gaussian msk) is CPFSK with modulation index $h_{mod} = 0.5$ and Gaussian phase basis pulses.
- * GMSK is the modulation format most widely used in Europe.
- * It is applied in the Cellular Global System for mobile communication (GSM) standard (with BGT = 0.3) and the cordless standard Digital enhanced cordless Telecommunications (DECT) (with BGT = 0.5). It is also used in the Bluetooth standard for wireless personal area network.
- * It is not worthy the GMSR cannot be interpreted as PAM. However, derived eqn that above the interpretation of GMSK with finite mmy.

Fig: Pulse sequence and phase of Gaussian MSK signal

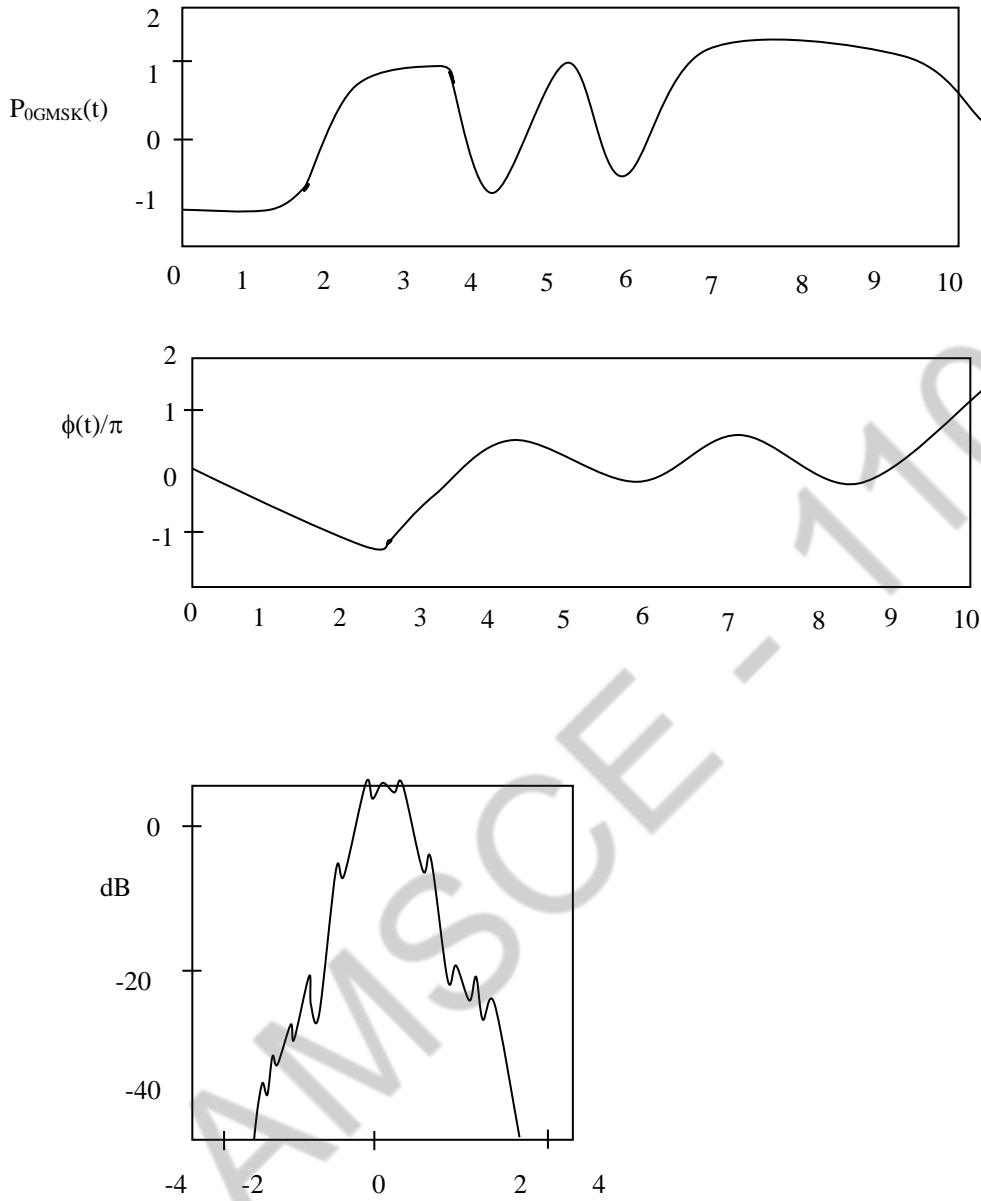

Since MSK is treated as special type of CPFSK the $X_{msk}(t)$ can be written as,

$$X_{msk}(t) = \sqrt{\frac{2E_b}{T_b}} \cos \left[\omega_c t - n_1(t) n_Q(t) \frac{\pi t}{2T_b} + \phi_k \right] \dots$$

$$= \sqrt{E_b} \cdot \sqrt{\frac{2}{T_b}} \cos \left[2\pi f_c t - n_1(t) n_Q(t) \frac{\pi t}{2T_b} + \phi_k \right] \dots$$

In which case ϕ_k is either 0 or π , it depends on the value of $n_1(t)$ which is either 1 or -1.

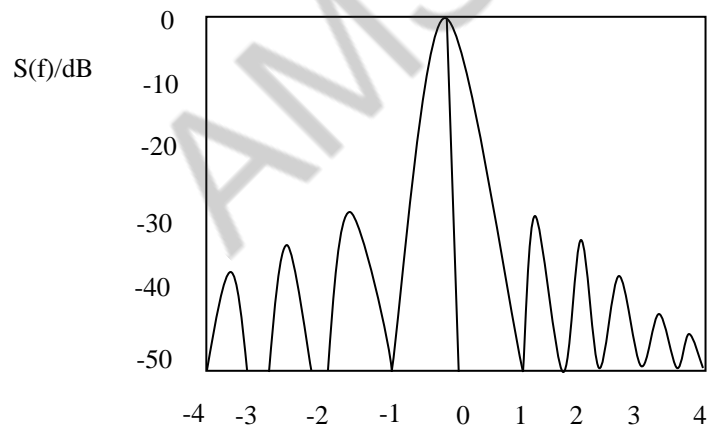
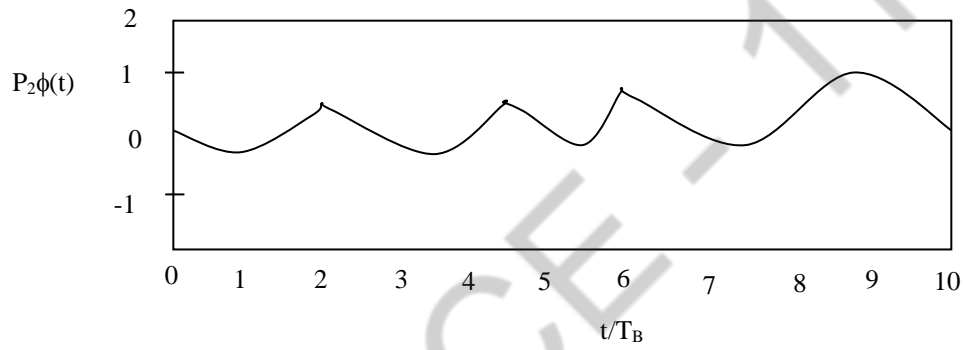
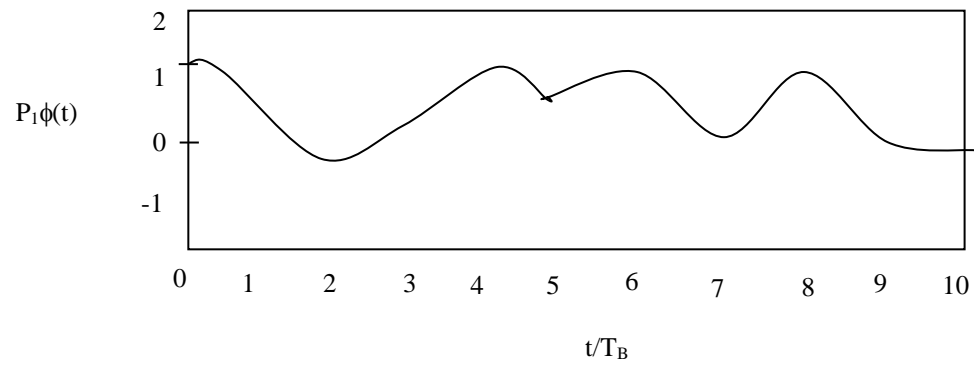

Fig: Power – Spectral density of minimum shift keying

7. Write short notes on Error performance in fading channels.

- * In fading channels, the received signal power is not constant but changes as the fading of the channel changes.
- * In many cases, we are interested in the BER in a fading channel averaged over the different fading states.
- * Determine the BER for any arbitrary SNR.
- * Determine the probability that a certain SNR occurs in the channel in other words, determine the pdf of the power gain of the channel.
- * In an AWGN channel, the BER decrease approximately exponentially as the SNR increases.
- * At first glance, this is astonishing.
- * The important point here is that the relationship between BER and SNR is highly non-linear. So that the cases of low SNR essentially determine the overall BER.

8. Explain OFDM (Orthogonal frequency Division Multiplexing)(APR/MAY 2017)

OFDM splits a high-rate data stream into N parallel streams, which are then transmitted by modulating N distinct carriers. (Henceforth called Subcarriers or tones).

$$F_n = n w/n$$

Where n is an integer.

W – the total available bandwidth

$$W = N/T_s$$

PAM with rectangular basis pulses.

$$\int_{iT_s}^{(i+1)T_s} \exp(j2\pi f_k t) \exp(-j2\pi f_n t) dt = \delta_n k$$

Due to the rectangular shape of pulses in the time domain, the spectrum of each modulated carrier has a $\text{sinc}(x)/x$ shape.

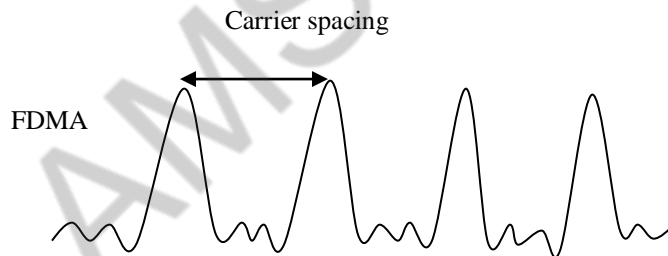
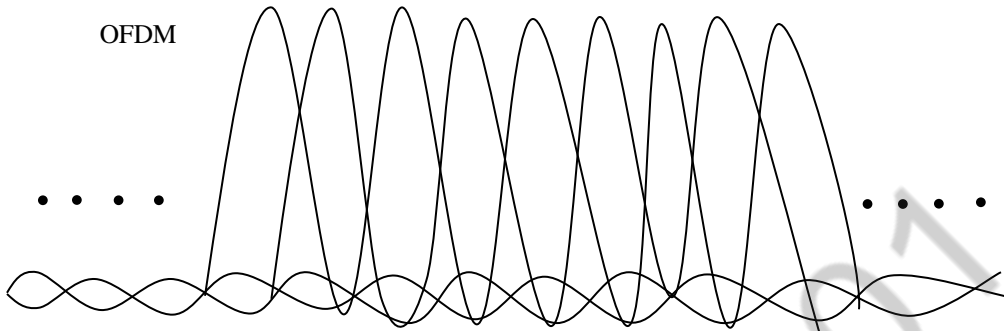

Fig: Carrier Spacing ω/N



Principle behind orthogonal frequency division multiplexing; N carriers within a bandwidth of w .

Implementation of Transceivers:

Split our original data stream into N parallel data streams each of which has a lower data rate.

$$f_n = nW/N$$

where $n = 0, 1, \dots, N-1$

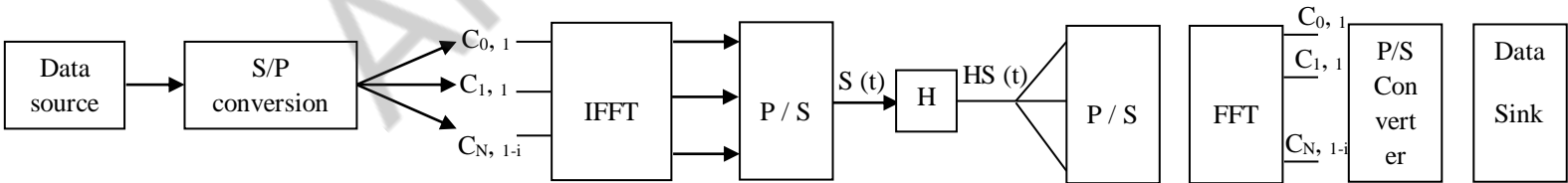
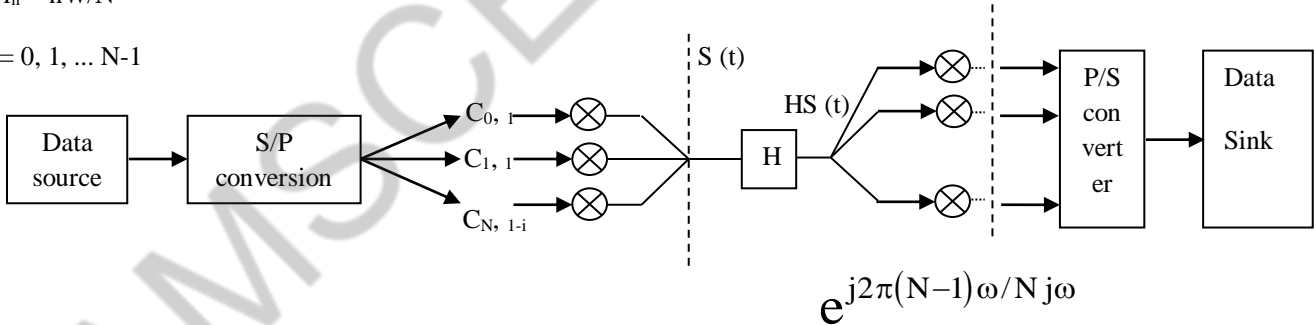

Transceiver structures for orthogonal frequency division multiplexing in purely analog technology a) and using inverse fast Fourier transformation b)

Cyclic prefix:

Delay dispersion also leads to a loss of orthogonality between the subcarriers, and thus to inter carrier interference (ICI).

Both these negative effects can be eliminated by a special type of guard interval called the cyclic prefix (CP)

$$g_n(t) = \exp \left[j2\pi n \left(\frac{W}{N} \right) t \right] \text{ for } -T_{cp} < t < \hat{T}_s$$

where again W/N is the carrier spacing and

$$T_s = N/W$$

The symbol duration T_s is now $T_s = T_s + T_{cp}$

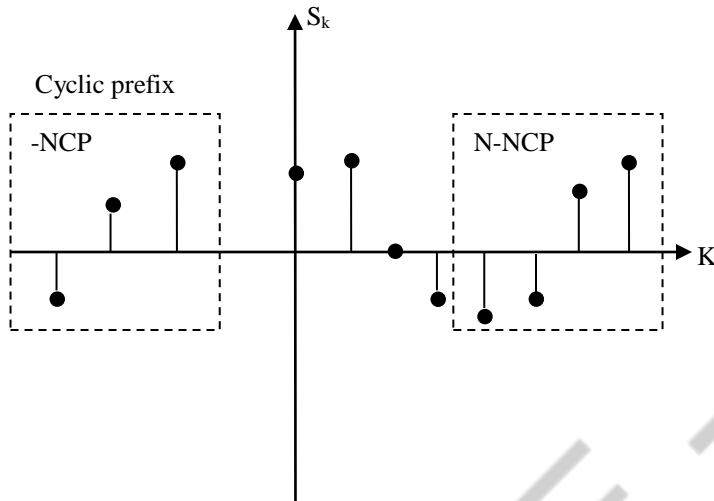

Major problems of OFDM

1. Peak to average power ratio (PAR)
2. Inter carrier interference (ICI)
3. Inter symbol interference (ISI)

Windowing:

Peak windowing. The simplest way to reduce the PADR is to clip the signal but this significantly increases the out of band radiation.

Ex: cosine, Kaiser and Hamming window

PAPR → Peak – to – Average Power ratio

Origin of the Peak – to – average problem. One of the major problems of OFDM is that the peak amplitude of the emitted signal can be considerably higher than the average amplitude.

PARP reduction Techniques:

1. Coding for PAR reduction
2. Phase adjustments
3. Correction by additive function

Inter carrier interference

The cyclic prefix provides an excellent way of ensuring orthogonality of the carriers in a delay – dispersive (frequency – selective) environment.

Unit-IV

Multipath mitigation Technique

PART A

1. What are the techniques used to improve the received signal quality.

Equalization, Diversity & channel coding.

2. What are the function of diversity.

(i) It is used to compensate for fading channel impairments.

(ii) It improves transmission performance by making use of more than one independent faded version of the transmitted signal.

3. Define spatial diversity.(?NOV/DEC 2017)

Multiple antennas are strategically spaced and connected to a common receiving system. When one antenna has zero signal and other may have peak signal. The receiver is able to select the antenna into the best signal at a time.

4. What is meant by principle of diversity?(APR/MAY 2017)

It is to ensure that the same information reaches the receiver (RX) on statistically independent channels.

5. What is the function of channel coding?

It is used to defeat (or) correct some of the errors introduced by the channel in a particular sequence of manage bits.

6. Define adaptive equalizer.(APR/MAY 2017)

The equalizer co-efficients should change according to the channel status so as to track the channel variations.

7. Define Linear equalizers.

If the output is not used in the feedback path to adapt then this is called Linear equalizer.

8. Define non-linear equalizer.

If the output is feedback to change the subsequent output of the equalizer this type of equalizer is called non-linear equalizers.

9. Compare macro and micro diversity.

| Macro diversity | Micro diversity |
|--|--|
| Large scale fading is caused by shadowing due to variations in both the terrain profile. | Small scale fading results is a Ray length distribution of signal strength over small distances. |
| The distance between the transmitter is much longer than the wave length in macro diversity. | In micro diversity the distance is in the order of or shorter than the wave length. |

10. Define switched diversity.

If the signal level falls below the threshold then the receiver switches to a new antenna.

11. Compare selection diversity & combining diversity.

| Selection Diversity | Combining Diversity |
|--|--|
| (i) The best signal is selected & processed while all other signals are discarded. | All signals are Combined before processing and the combined signal is decoded. |
| (ii) Simple circuits are used. | At individual receiver phasing circuits are needed. |

12. What are the non-linear equalization methods used?

- (i) Decision feedback equalization.
- (ii) Maximum likelihood symbol detection.
- (iii) Maximum likelihood symbol estimation.

PART - B

1. Explain the following types of diversity techniques.(APR/MAY 2017)(NOV/DEC 2017)

- 1. Angle diversity 2. Polarization. 3. Spatial diversity.

1. Angle diversity

- * Two co-located antenna elements with different radiation patterns they may be interference due to multipath components. This known as angle diversity (or) pattern diversity.

- * It can be used in conjunction with spatial diversity. It is possible to attain different antenna patterns.
- * Here closely spaced antenna with angle diversity.
- * If identical antennas are used and mounted close to each other they will have different radiation patterns.

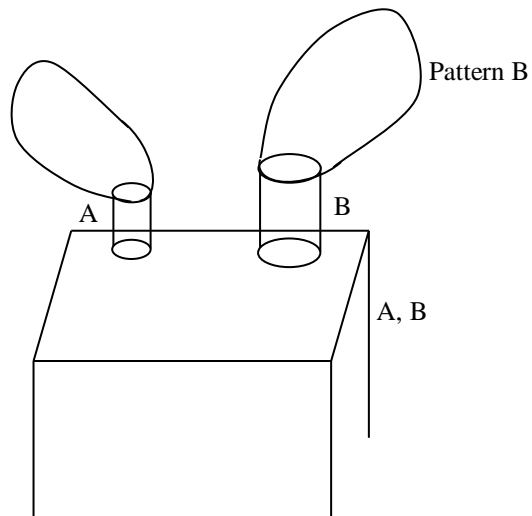

- * This effect is because of closely spaced antennas the mutual coupling.

2. Polarization diversity

- * The signal is received in both vertical and horizontal polarization.
- * Fading of the two received signals is independent but the average received signal strength in the two diversity.

1. Polarization angle.
2. Cross polarization discrimination
3. Offset angle from that of the main beam direction of diversity antenna setup.

Thus polarization diversity is one of the best technique in diversity reception and it can be applied for mobile unit and the best station.

2. Explain linear equalizers.(APR/MAY 2017)(NOV/DEC 2017)

Linear equalizers are simple linear filter structure that try to invert the channel in the sense that the product of the transfer functions of channel and equalizer fulfils a certain criterion.

This filter should convert sequence $\{u_i\}$ into sequence $\{c_i\}$

$$\hat{c}_i = \sum_{n=-k}^k e_n u_{i-n}$$

$$\varepsilon_i = c_i - \hat{c}_i$$

$$\varepsilon_i = 0 \text{ for } N_0 = 0$$

ZF equalizer, $E = \{|\epsilon_i|^2\} \rightarrow \min$ for N_0 having a finite value.

Which gives the minimum means square error (MMSE) equalizer.

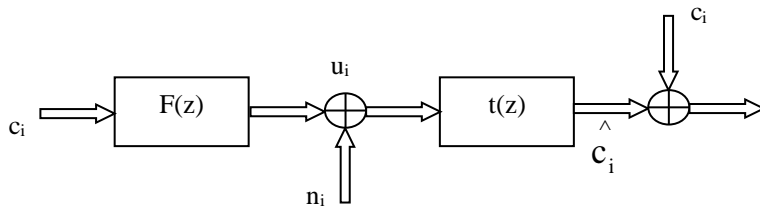
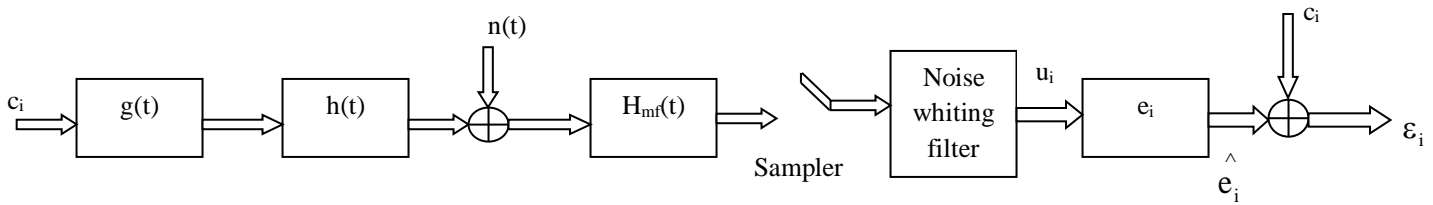

Linear equalizer in the time domain

a) and time – discrete equivalent system in the z-transform domain b).

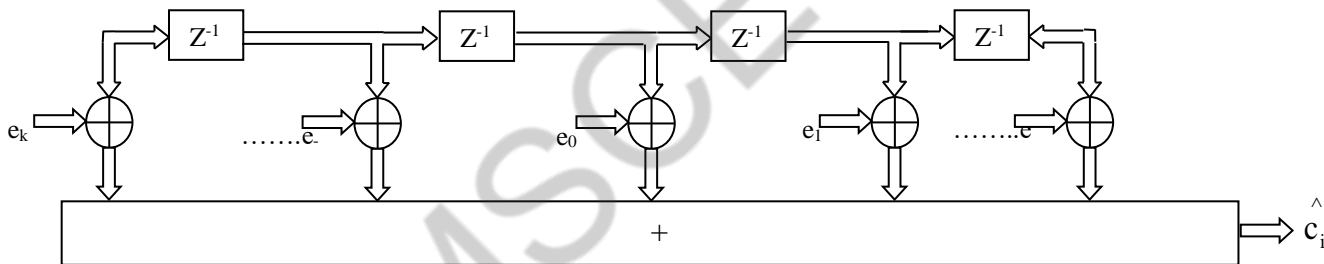

i) Zero – forcing Equalizer

The ZF equalizer is optimum for elimination of ISI. However, channels also add noise, which is amplified by the equalizer.

(ii) The mean Square Error Criterion

$$MSE = E \{ (S_i)^2 \} = E \{ \epsilon_i \epsilon_i^* \}$$

$$E_{opt} = R^{-1} P$$

Where $R = E\{u * u^T\}$ is the correlation matrix of the received signal.

$P = E\{u * c_1\}$ The cross correlation between the received signal and the transmit signal.

(iii) Adaptation Algorithms for mean square

Error Equalizers:

1. Convergence rate
2. Misadjustment

(iv) Least Mean Square Algorithm

1. Initialize the weights with value e_0 .
2. Compute an updated estimate of the weight vector e by adjusting weights in the direction of the negative gradient.
3. If the stop criterion is fulfilled.

(v) The recursive least squares algorithm.

The LMS coversages very slowly.

The use of this algorithm is justified only when the statistical properties of the received signal fulfil certain conditions.

4. Explain Non-linear (Decision feedback Equalizer).(APR/MAY 2017)(NOV/DEC 2017)

Structure of a decision feedback equalizer.

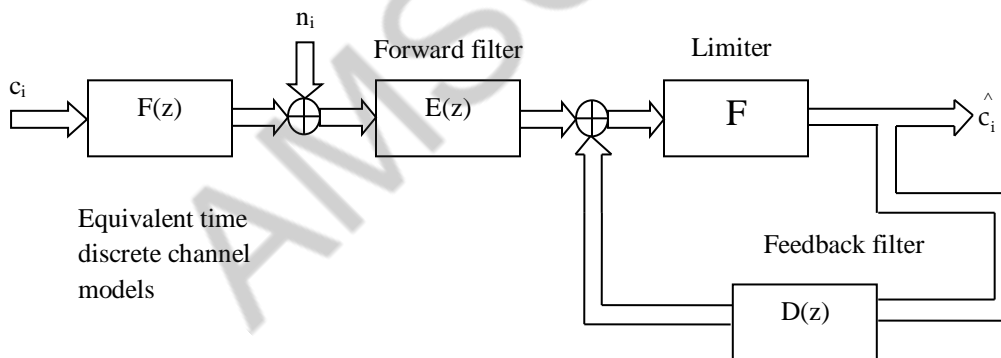

i) MMSE Decision feedback equalizer.

The goal of the MMSE DFE is again minimization of the MSE, by striking a balance between noise enhancement and residual ISI.

The MSE at the equalizer output.

$$\sigma_n^2 \text{DFE} - \text{MMSE} = N_0 \exp \left(\frac{T_s}{2\pi} \int_{-\pi/T_s}^{\pi/T_s} \ln \left[\frac{1}{E(e^{j\omega T}) + N_0} \right] d\omega \right)$$

(ii) Zero – Forcing Decision feedback equalizer.

The ZF DFE is conceptually even simpler.

The noise – whitening filter eliminates all precursor ISI, such that the resulting effective channel is purely causal.

Post cursor ISI is subtracted by the feedback branch.

$$\sigma_n^2 (\text{DFE} - \text{ZF}) = N_0 \exp \left(\frac{T_s}{2\pi} \int_{-\pi/T_s}^{\pi/T_s} \ln \left[\frac{1}{E(e^{j\omega T})} \right] d\omega \right)$$

5. Explain Macrodiversity.

Microdiversity methods that combat small – scale fading. i.e., the fading created by interference of MPCPS.

1. Signal combining techniques.

1. Selection diversity → where the best signal copy is selected and processed.
2. Combining diversity → where all copies of the signal are combined

Due to two effects:

1. Diversity gain
2. Beam forming gain

1. Selection Diversity:

Received - signal - Strength - Indication - Driven diversity

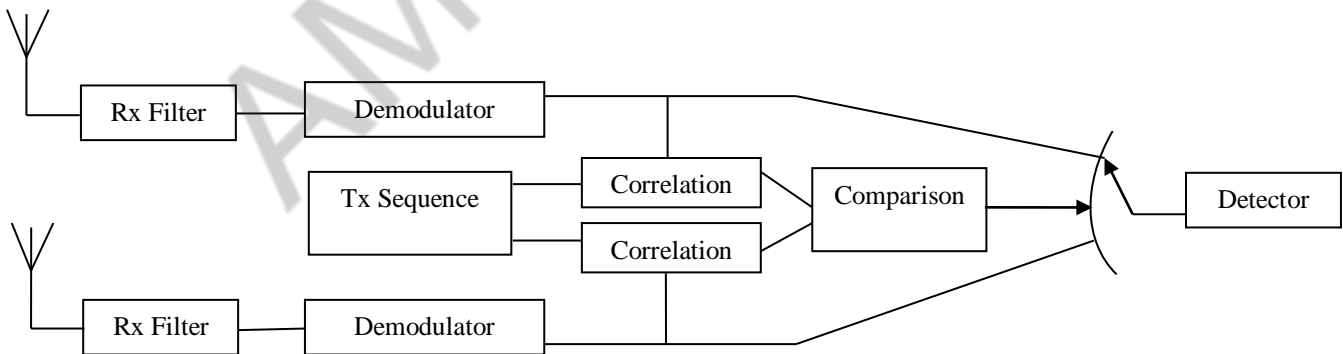

Bit – error – rate – driven diversity:

For BER – driven diversity, we first transmit a training sequence. i.e., a bit sequence that is known at the receiver.

Switched Diversity:

Principle: Active diversity branch is monitored. If it falls below a certain threshold, then the receiver switches to a different antenna. Switching only depends on the quality of the active diversity branch.

Combining diversity:

Principle: Selection diversity wastes signal energy by discarding ($N_r - 1$) copies of the received signal. This drawback is avoided by combining diversity.

Two methods are widely used:

- 1. Maximum Ratio Combining (MRC)
- 2. Equal Gain combining (EGC)

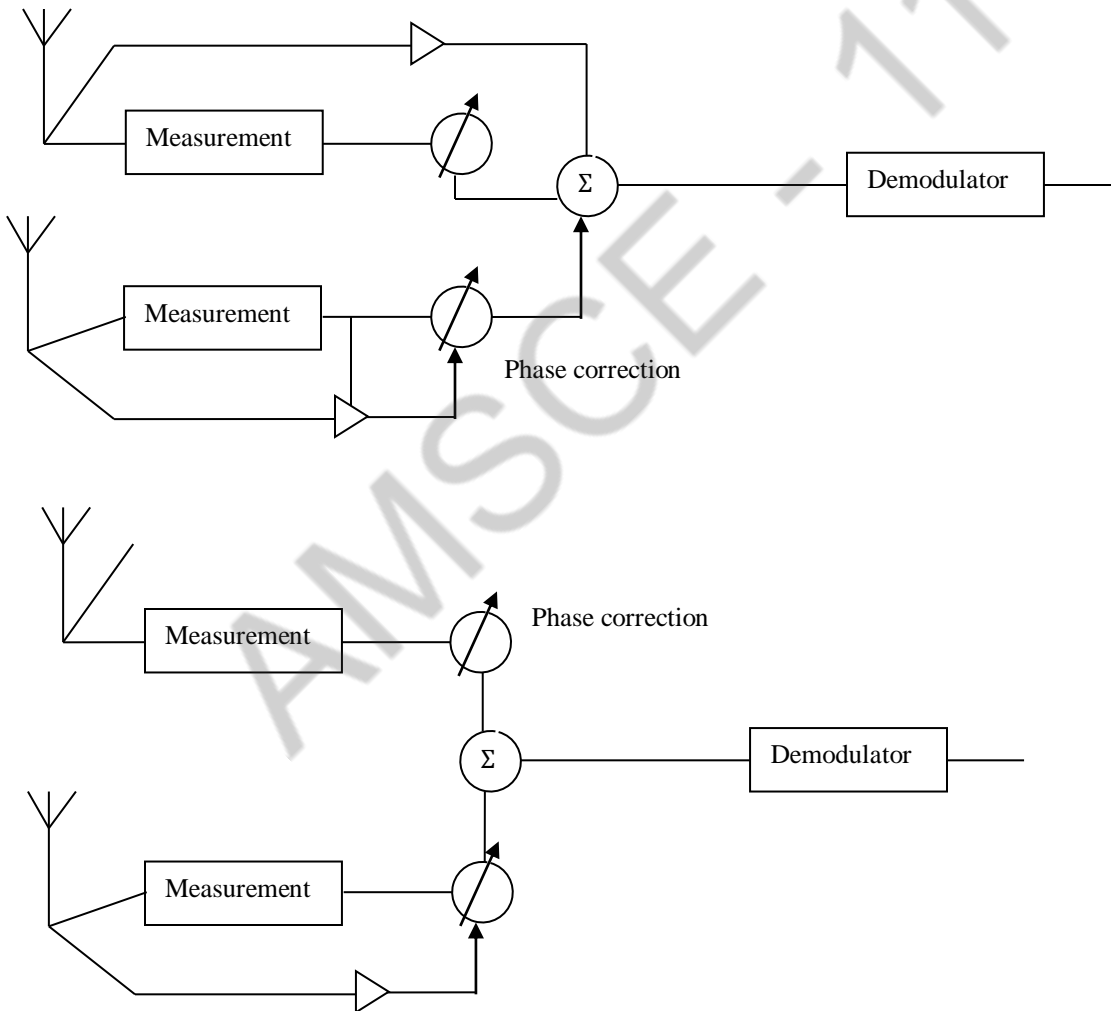

Equal Gain combining (EGC)

For EGC,

$$\text{Output } \gamma_{\text{EGC}} = \frac{\left(\sum_{n=1}^{N_r} \sqrt{\gamma_n} \right)^2}{N_r}$$

Optimum combining:

Hybrid selection – Maximum Ratio combining:

A compromise between selection diversity and full signal combining is the so called hybrid selection.

6. Explain Error probability in fading channels with Diversity Reception.

The Symbol Error rate (SER) in fading channels when diversity is used at the receiver. The case of flat – fading channels, computing the statistics of the received power and the BER.

Error probability in flat-fading channels classical computation method.

$$\overline{\text{SER}} = \int_0^{\infty} \text{pdf}_{\gamma}(\gamma) \text{SER}(\gamma) d\gamma$$

Symbol Error rate in Frequency selective fading channels:

$$\overline{\text{SER}} = \frac{(2N_r - 1)!!}{2(N_r!) } \left(\frac{1 - |P_{xy}|^2}{2(\text{Im}\{P_{xy}\})^2} \right)^{N_r}$$

7. Explain Rate receiver (APR/MAY 2017)

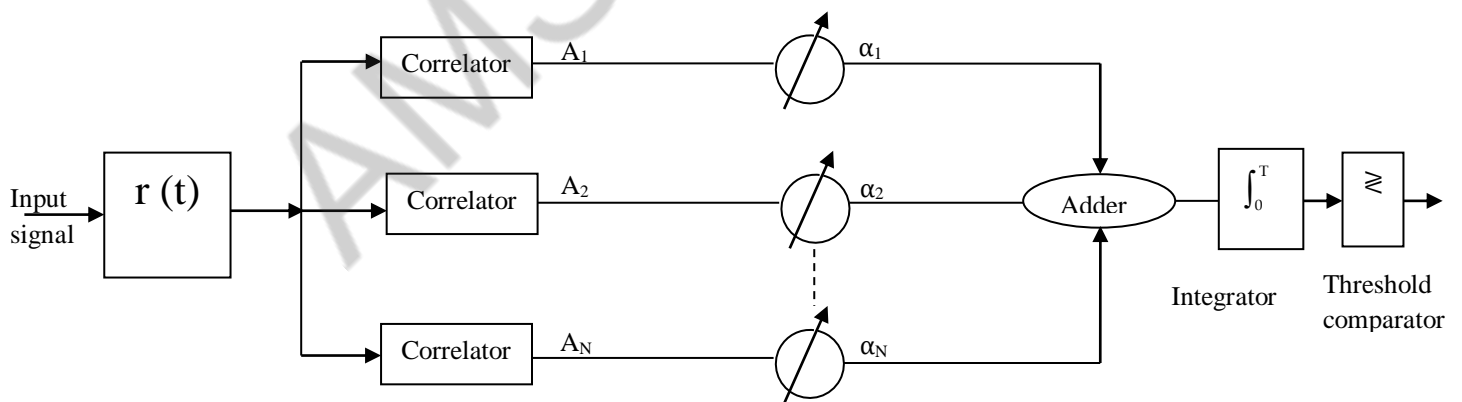

- * A rate receiver collects the different time delayed versions of original signal so that in multipath environment, if any useful information available in multipath components is not left out.
- * By receiving all possible multiple components with the help of separate correlation receivers for each multipath a better signal to noise ratio is achieved and finally it will lead to signal quality.

$$* \quad A' = \sum_{n=1}^N \alpha_n \cdot A_n$$

Where $\alpha_n \rightarrow$ weighting coefficients

Unit-V

Multiple Antenna Techniques

PART A

1. Define MIMO system.

MIMO systems are system with multiple element Antennas (MEAS) at both transmitter and receiver. MIMO system offers high data rates and lower error rates.

2. Compare selection diversity & combining diversity.

| Selection Diversity | Combining Diversity |
|--|--|
| (i) The best signal is selected & processed while all other signals are discarded. | All signals are Combined before processing and the combined signal is decoded. |
| (ii) Simple circuits are used. | At individual receiver phasing circuits are needed. |

3. Define spatial multiplexing.(APR/MAY 2017)

It uses MEAS at the transmitter for transmission of parallel data streams. An original high rate data stream is multiplexed into several parallel streams.

4. What is precoding?

Precoding scheme is designed to minimize the mean squared error between the transmitted and received data with a per user power constraint. It allows to perform many complex processing at BS or Access point (AP).

5. Define Beam forming.

Beam forming or smart antenna system user phased array of antennas for transmitter & receiver. It can be used in any antenna system to create a required antenna directive pattern to give the required performance.

6. Define SDMA.

Space division multiple access controls the radiated energy for each user in space. It serves different users by using spot beam antennas.

7. Define Transmit diversity.

It is achieved by transmitting signals from several transmit antenna.

Two cases are considered:

- (i) Transmitter diversity with the channel state information.
- (ii) Transmitter diversity without the channel state information.

8. What is meant by frequency diversity?

Correlation is increased by transmitting information on more than one carrier frequency . Frequency are separated by more than one coherence bandwidth of the channel.

9. Define receiver diversity.

It uses two separate collocated antennas for receive functions. Such a configuration elimination the need for a diplexer and can protect sensitive receiver components from the high power used in transmit.

10. Compare Micro and Macro diversity.

| Micro diversity | Macro diversity |
|---|---|
| (i) Small scale fading results | Large scale fading is caused by shadowing due to variation in both terrain profile. |
| (ii) Used to reduce small scale fading. | Used to reduce large scale fading effects. |
| (iii) Multiple reflection causes deep fading. | Deep shadow causes fading. This effect is reduced. |

1. Explain MIMO systems.(NOV/DEC 2017)(APR/MAY 2017)

A MIMO systems comprises of antenna elements and adaptive signal processing procedures at transmitter and receiver.

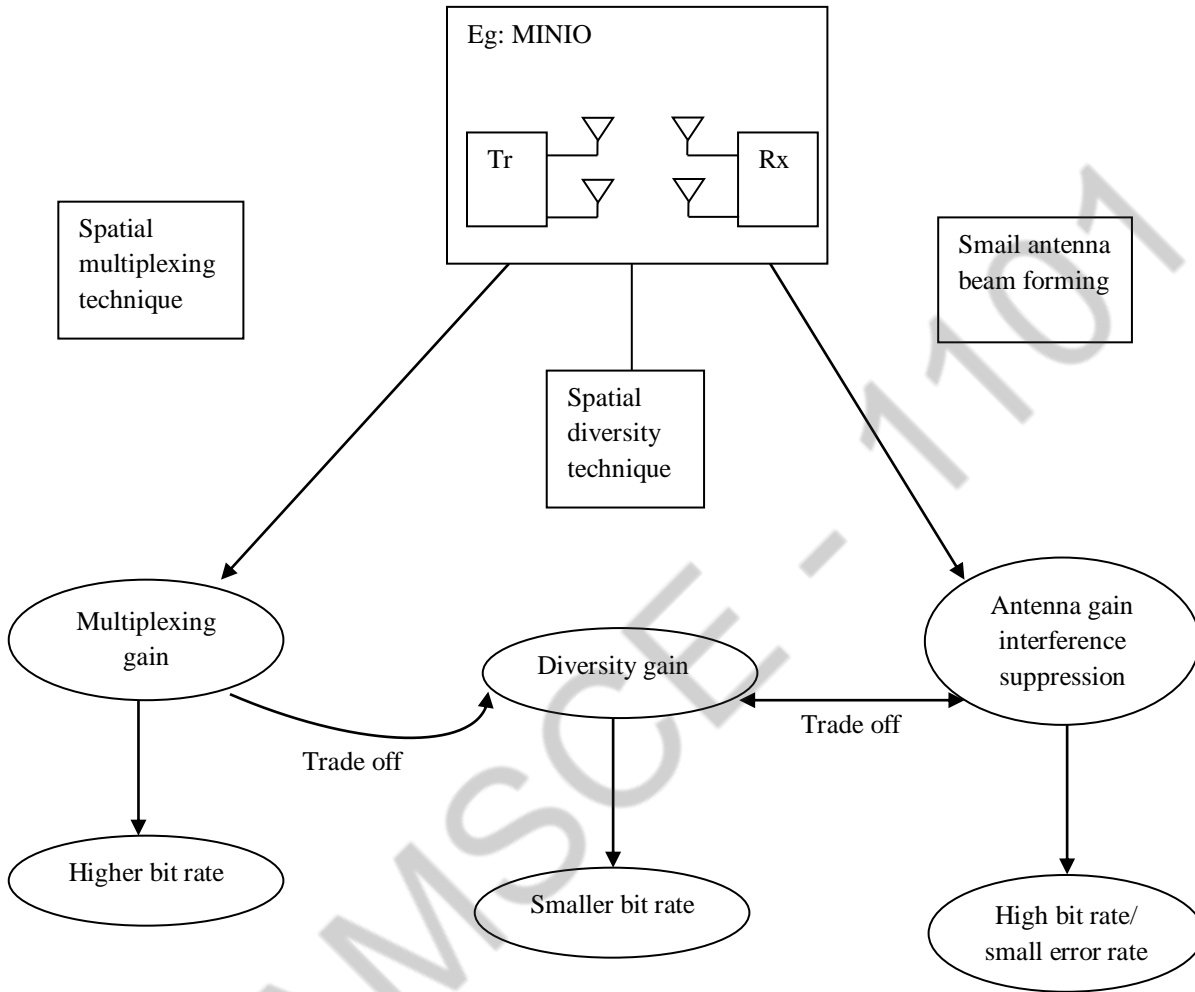

Advantages:

Higher capacity, Bit transmission quality. High coverage capacity. Increased data rates.

For better performance of MIMO systems low complexity receivers and evaluation of system gain have to accounted in design.

2. Explain beam forming technique and precoding technique in detail.(NOV/DEC 2017)(APR/MAY 2017)

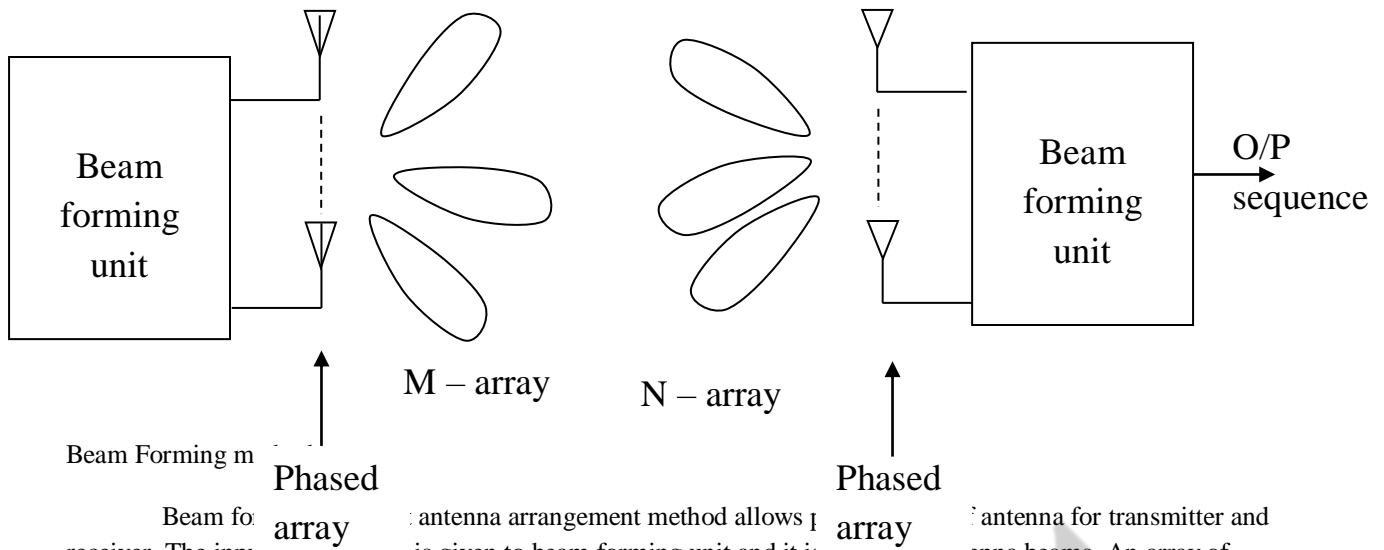

Beam Forming m... Beam fo... array... antenna arrangement method allows p... receiver. The input... sequence is given to beam forming unit and it is... antenna beams. An array of antenna are used. This signal is received with phased arrays at receiver end and processed.

Precoding:

Precoding allows to perform many complex processing at BS. It helps simplification at users end.

Another precoding technique is known as Successive Optimization Technique (SOT)

1. Power allocation
2. The order of pre-processing of subscribers signals,

Block diagonalization Technique.

The precoder matrices will be as

$$P = [P_1, P_2, P_3, \dots P_k] \in \mathbb{C}^{ATXr}$$

Where $P_i \in \mathbb{C}^{ATXr_i}$ is the i^{th} user or subscribers $r \leq AR$ is the no of txed data streams.

$r_i \leq Ari$ is the no of data streams, that is txed to an i^{th} user.

Non-linear precoding:

The minimum – mean – square –error (MMSET) is another precoding technique and it is applied in combination with THT precoding principle.

It helps to balance MUI and reduce the performance losses to some extent in MIMO systems.

3. Explain spatial multiplexing

Goal: Increased data rates compared to single antenna. Capacity of MIMO systems grows linearly with $\min\{M, N\}$

Spatial multiplexing uses mE As at the Tx for transmission of parallel data streams, each of which is sent from one transmit antenna element.

Propagatin channel.

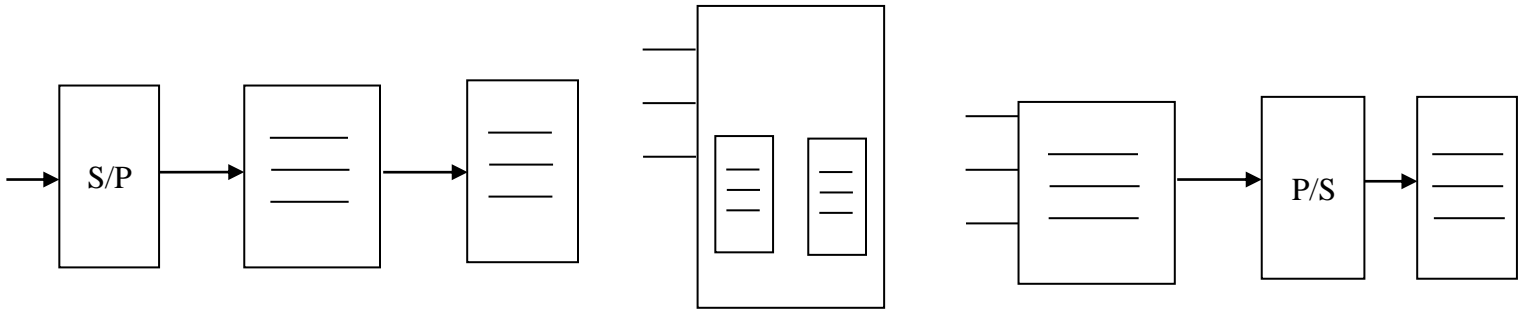

Principle behind spatial multiplexing

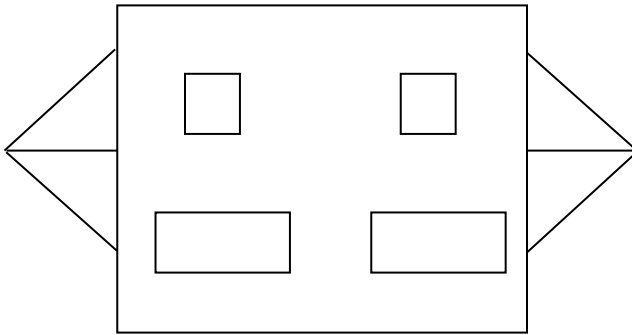

Transmission of different data streams via different interacting objects.

Principles: The number of possible data streams is limited by $\min(N_t, N_r, N_s)$, where N_s is the number of 10s.

If two data streams are txed to the same 10 then the Rx has no possibility of sorting them out by forming different beams.

4. Write about the system model.

By quasi-state we mean that the coherence time of the channel is so long that a large number of bits can be txed within this time.

$$H = \begin{pmatrix} h_{11} & h_{12} & \dots & h_{1N_t} \\ h_{21} & h_{22} & \dots & h_{2N_t} \\ h_{N_r1} & h_{N_r2} & \dots & h_{N_rN_t} \end{pmatrix}$$

The received signal vector $r = Hs + n = X + n$ contains the signals received by N_r antenna elements, where S is the transmit signal vector and n is the noise vector.

5. Explain Transmitter Diversity with channel state information.

- * The first situation we analyze is the case where the Tx knows the channel perfectly.
- * BER – driven selection diversity is preferable For $N_r = 2$, the BER of minimum shift keying (MSK) with differential detection becomes where the h_n are gains from the n^{th} transmit antenna to the receive antenna. This approach is known as maximum ratio transmission.

The signals from different transmit to the receiver act effectively as delayed MPCs.

If antenna elements are spaced sufficiently far apart. These coefficients fade independently with an appropriate receiver for delay – dispersive channels.

Channel state information

1. Full CSI at the Tx CSIT and full CSI at RX (CSIR)
2. Average CSI at the Tx (CSIT) and full CSI at the Rx

Slow feedback:

1. No CSIT and full CSIR
2. Noisy CSI

$$H_{\text{true}} = H_{\text{obs}} + \Delta$$

No CSIT and no CSIR. It is remarkable that channel capacity is also high when neither the Tx nor the Rx have CSI.

6. Explain capacity in Non-fading channels.

MIMO systems in non-fading channels often known as Focchini's equation

AWGN channels

$$C_{\text{shannon}} = \log_2 (1 + \gamma |\varphi|^2)$$

Where φ is the SNR at the Rx and H is the normalised transfer function from the Tx to the RX.

The capacity of channel H is thus given by the sum of the capacities of the Eigen modes of the channel.

$$C = \sum_{k=1}^{R_H} \log_2 \left[1 + \frac{P_k}{\sigma_n^2} \sigma_k^2 \right]$$

Where σ^2 is noise variance and P_u is the power allocated to the K^{th} eigen mode

$P_k = P$ is independent of the no of antennas

$$C = \log_2 \left[\text{de} \left(I_{N_r} + \frac{\gamma}{N_t} HR_{ss} \right) \right]$$

7. Explain capacity in flat – fading channels.(NOV/DEC 2015)

If the channel is Rayleigh fading and fading is independent at different antenna elements, the h_{ij} are iid zero-mean, circularly symmetric complex Gaussian random variables with unit variance. ie real and imaginary part each has variance $\frac{1}{2}$.

1. Ergodic capacity
2. Outage capacity. eg; 90% or 95%

The exact expression for the ergodic capacity

$$E(c) = \int_0^{\infty} \log_2 \left[1 + \frac{\bar{\gamma}}{N_1} \lambda \right] \sum_{k=0}^{m-1} \frac{K!}{(K+n-m)!} \left[L_k^{n-m}(\lambda) \right]^2 \lambda^{n-m} \exp(-\lambda) d\lambda$$

Where $m = \min (N_t, N_r)$

and $n = \max (N_t, N_r)$

and $L_{nj} - m(x)$ are associated laguerie polynomials

$N_t > N_r$

$$\sum_{k=N_t-N_r+1}^{N_t} \log_2 \left[1 + \frac{\bar{\gamma}}{N_t} X_{2k}^2 \right] < C < \sum_{k=1}^{N_t} \log_2 \left[1 + \frac{\bar{\gamma}}{N_t} X_2^2 N_r \right]$$

AMSCSE-1101